

# PIPE VALVES AND FITTINGS

**BuTech Pipe Valves** are designed for liquid and gas flow control in petroleum, chemical, power generating and general industrial applications.

Available in a variety of body styles, the valves are designed for manual operation in temperatures ranging from -100° to +600°F (-73° to +315°C). Optional packings and/or extended stuffing boxes increase the range to -423° to +1200°F (-253° to +648°C).

Their rugged construction provides assurance of fail-safe operation at pressures ranging to 15,000 PSI (1030 bar).

## Needle Valve Features:

- Non-rotating stem prevents galling and scoring
- Five stem styles:
  - Vee                      •Metering
  - Regulating          •Micro-Metering
  - Soft Tip
- 17-4PH Stem for longer service life. 316 wetted parts are also available by specifying option **-316WP** (see page NPT-3)
- Glass-filled PTFE packing for temperatures to 600°F (315°C)
- Integral through holes for bracket mounting. A panel-mounting option is also available (see page NPT-3)
- Wide range of options allow customizing of valve

## Materials of Construction

Standard materials of construction include 316 cold-worked stainless steel, 17-4PH, Ampco 45, and glass-filled PTFE. All BuTech equipment may also be produced in any machinable metal. Some of the more common exotic materials used are:

- Hastelloy™
- Inconel™
- Titanium
- Monel 400™

**Pipe Sizes: 1/8" through 1"**  
**Pressures to 15,000 PSI (1030 bar)**  
**Type: NPT**

Pipe Size	Connection	SFPV/FPV Series		DHP Series		MAWP+
		Orifice	Cv*	Orifice	Cv*	
1/8"	1/8" NPT	0.187" (4.7 mm)	0.65	0.187" (4.7 mm)	0.60	15,000 PSI 1030 bar
1/4"	1/4" NPT	0.250" (6.4 mm)	0.75	0.250" (6.4 mm)	0.73	15,000 PSI 1030 bar
3/8"	3/8" NPT	0.312" (7.9 mm)	1.75	0.250" (6.4 mm)	0.73	15,000 PSI 1030 bar
1/2"	1/2" NPT	0.312" (7.9 mm)	1.75	0.250" (6.4 mm)	1.75	15,000 PSI 1030 bar
3/4"	3/4" NPT	0.562" (14.3 mm)	3.40	0.687" (17.4 mm)	5.20	10,000 PSI 690 bar
1"	1" NPT	0.562" (14.3 mm)	3.40	0.687" (17.4 mm)	5.20	10,000 PSI 690 bar

\*Cv values listed are for 2-way straight pattern valves excluding metering valves.

For 2-way angle pattern valves, increase Cv value by 50%.

For Metering Valves: Cv=.004, Port size=0.062" (1.57 mm)

+Maximum allowable working pressure at 72° F (22° C)

Equipment	Page
Adapters	NPT-21
Bulkhead Couplings	NPT-20
Caps	NPT-23
Check Valves	NPT-25
Couplings	NPT-22
Crosses	NPT-20
Elbows	NPT-18
Filters	NPT-27
Manifold Valves	NPT-16
Metering and Needle Valves, 1/8"	NPT-4
Metering and Needle Valves, 1/4"	NPT-6
Metering and Needle Valves, 3/8"	NPT-8
Needle Valves, 1/2"	NPT-10
Needle Valves, 3/4"	NPT-12
Needle Valves, 1"	NPT-14
Nipples	NPT-24
Options	NPT-3
Plugs	NPT-23
Replaceable Seat Valves	NPT-17
Safety Heads	NPT-28
Tees	NPT-19
Zero-Clearance Unions	NPT-23

All dimensions are for reference only and are subject to change.  
 Dimensions in parentheses are millimeters (mm)

# ORDERING INFORMATION & REPLACEMENT PARTS

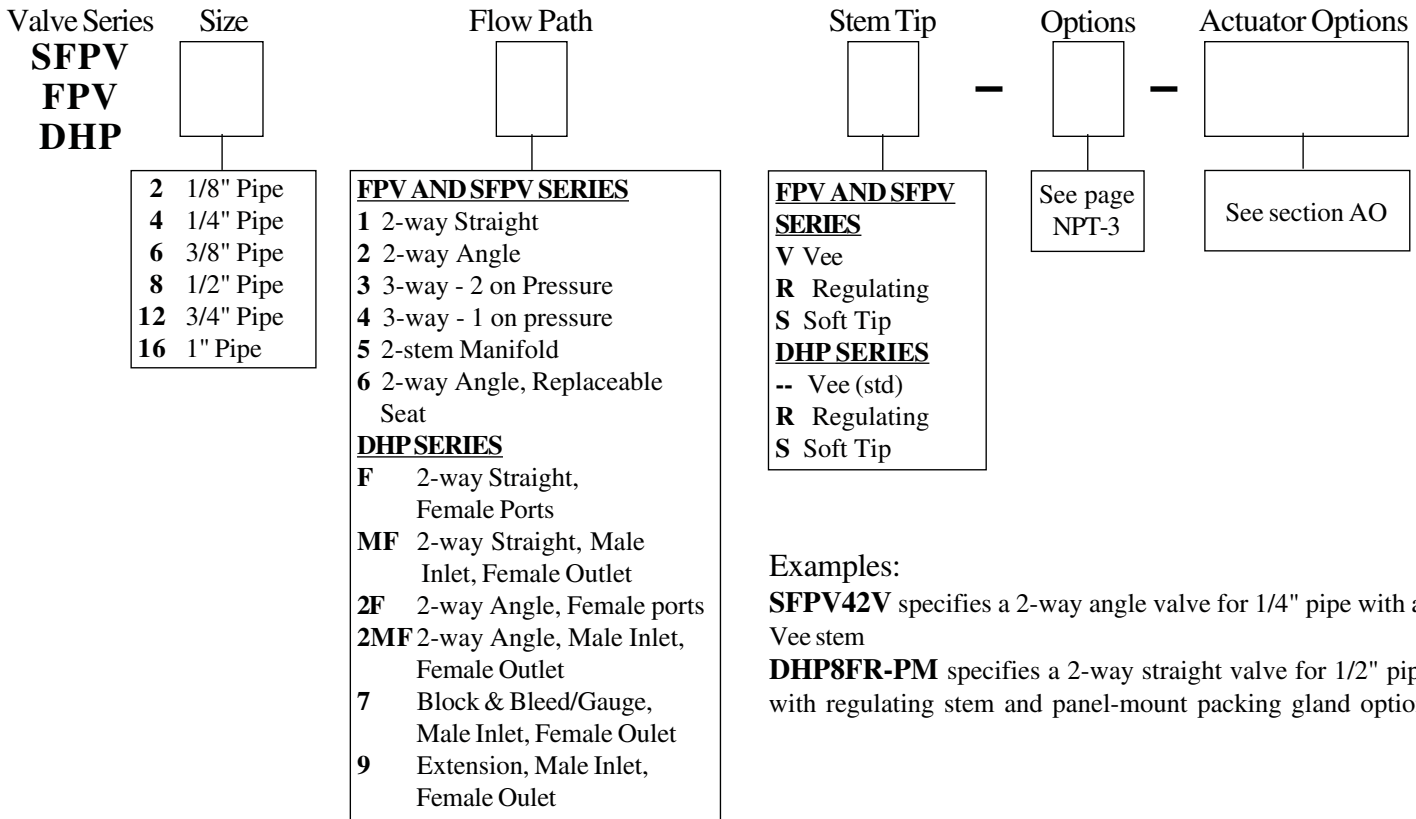

## Replacement Parts

BuTech offers replacement parts in a variety of packages so you can purchase just the parts you need.

**Replacement Stem Kit** contains just the stem

**Replacement Packing Kit** contains all soft packing rings

**Repair Kits** contain stem, stem sleeve, stem nuts and washers, packings and packing washers (replacement seat where applicable)

Valve Series	Repair Kits		Replacement Stem	Replacement Packings	Replacement Valve Body
	All others	Replaceable Seat			
SFPV2	RK-SFPV2*	RK-SFPV26*	FPS2*	FPPK2	SFPV2+
SFPV4	RK-SFPV4*	RK-SFPV46*	FPS4*	FPPK4	SFPV4+
SFPV6	RK-SFPV6*	RK-SFPV66*	FPS6*	FPPK6	SFPV6+
SFPV8	RK-SFPV8*	RK-SFPV86*	FPS8*	FPPK8	SFPV8+
FPV12	RK-FPV12*	RK-FPV126*	FPS12*	FPPK12	FPV12+
FPV16	RK-FPV16*	RK-FPV166*	FPS16*	FPPK16	FPV16+
DHP	RK-DHP**	----	DHPS**	DHPPK**	DHP+-BO

\*Complete catalog number by adding the following:

**V, R or S** for stem type

**Suffix** for special packing materials (see page NPT-3)  
(ex. **-GR** for Grafoil packings)

**Suffix** for special materials  
(ex. **-HC** for Hastelloy)

**-LT** or **-HT** for cryogenic or high-temperature service

**-WAO** for a valve fitted with an actuator

\*\*Complete catalog number by adding the size designator from above

+Complete catalog number by adding the flow path designator:

- 1** 2-way straight
- 2** 2-way angle
- 3** 3-way, 2 connections on pressure
- 4** 3-way, 1 connection on pressure
- 5** 2-stem manifold
- 6** 2-way angle with replaceable seat

++Complete catalog number by adding the flow path designator:

- F** 2-way straight, female ports
- MF** 2-way straight male inlet, female outlet
- 2F** 2-way angle, female ports
- 2MF** 2-way angle male inlet, female outlet
- 7** Block & Bleed/Gauge, male inlet, female outlet
- 9** Extension male inlet, female outlet

All dimensions are for reference only and are subject to change.  
Dimensions in parentheses are millimeters (mm)

# NEEDLE VALVE OPTIONS

## Packing and Stem Materials

- GR Grafoil packings for service to 800°F (426°C)
- TFE Virgin PTFE packing for service to 450°F (232°C)
- 316WP 316 wetted parts
- STS Stellite tipped stem
- SRS Stellite replaceable seat (Replaceable seat valves only)

## Handle Options

- PH Round plastic handle in place of aluminum (available on 1/8" through 1/2" sizes)
- SS Stainless steel handle in place of aluminum (available on 1/8" through 1/2" sizes, on 3/4" and 1" SS is standard)
- EXT\_ Handle extended above valve body, specify number of inches of extra height desired (Ex: **EXT6** is a 6" extension)

## Security Options

- HLD Handle locking device (prevents unauthorized opening/closing of valve)
- SLD Stem locking device (prevents stem from turning due to vibration)

## Extreme Service

- O2 Cleaned for oxygen service
- HT Extended stuffing box and special materials for high-temperature service to 1200°F (648°C)
- HTF Finned extended stuffing box and special materials for high-temperature service to 1200°F (648°C)
- LT Extended stuffing box and special materials for cryogenic service to -423°F (-251°C)
- LTF Finned extended stuffing box and special materials for cryogenic service to -423°F (-251°C)

Valve Model	A
SFPV2	5.82"
SFPV4	(147.8)
SFPV6	7.22"
SFPV8	(183.4)
FPV12	10.76"
FPV16	(273.3)
DHP2	5.82"
DHP4	
DHP6	
DHP8	
DHP12	10.85"
DHP16	
	(275.6)

### -HT or -LT Options

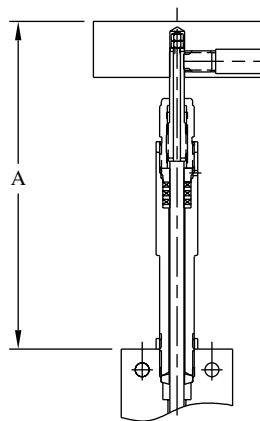

Cylindrical Bonnet

### -HTF or -LTF Options

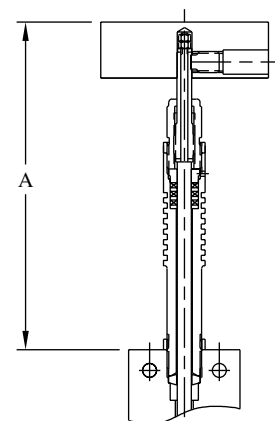

Finned Bonnet

## Panel Mount

- PM Panel-mount packing gland

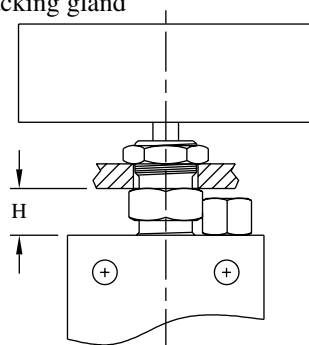

Valve Model	Panel Hole Size	Max Panel Thickness	H
SFPV2	0.66"	0.25"	0.54"
SFPV4	(16.8)	(6.4)	(13.7)
SFPV6	0.78"	0.44"	0.50"
SFPV8	(19.8)	(11.2)	(12.7)
FPV12	1.41"	0.62"	0.97"
FPV16	(35.8)	(15.7)	(24.6)
DHP2	0.64"	0.44"	0.50"
DHP4			
DHP6			
DHP8			
DHP12	1.41"	0.62"	1.03"
DHP16			
	(35.8)	(15.7)	(26.2)

All dimensions are for reference only and are subject to change.  
Dimensions in parentheses are millimeters (mm)

# NEEDLE VALVES FOR 15,000 PSI (1030 BAR)

## 1/8" PIPE

**2-way Straight**

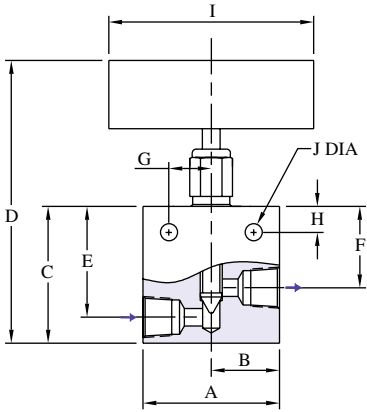

Figure 1

**2-way Angle**

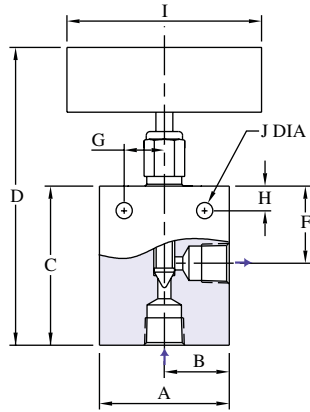

Figure 2

**3-way Two on Pressure**

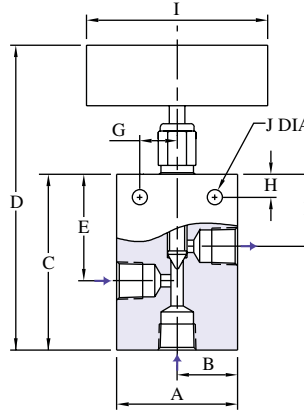

Figure 3

**3-way One on Pressure**

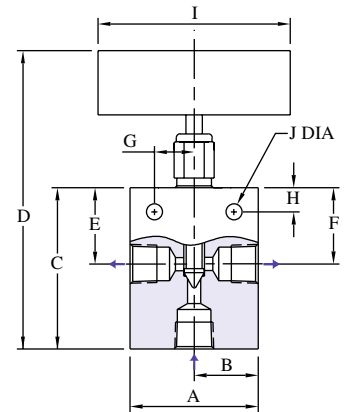

Figure 4

Catalog Number	Stem Style	Connection	A	B	C	D	E	F	G	H	I	J	K	L	Thk.	Fig
SFPV21V SFPV21R	Vee Reg	1/8" NPT	2.00" (50.8)	1.00" (25.4)	2.00" (50.8)	4.50" (114.3)	1.62" (41.1)	1.19" (30.2)	0.62" (15.7)	0.38" (9.7)	3.00" (76.2)	0.25" (6.4)	---	---	0.75" (19.1)	1
SFPV22V SFPV22R	Vee Reg	1/8" NPT	2.00" (50.8)	1.00" (25.4)	2.44" (62.0)	4.94" (125.5)	---	1.19" (30.2)	0.62" (15.7)	0.38" (9.7)	3.00" (76.2)	0.25" (6.4)	---	---	0.75" (19.1)	2
SFPV23V SFPV23R	Vee Reg	1/8" NPT	2.00" (50.8)	1.00" (25.4)	2.62" (66.5)	5.12" (130.0)	1.62" (41.1)	1.19" (30.2)	0.62" (15.7)	0.38" (9.7)	3.00" (76.2)	0.25" (6.4)	---	---	0.75" (19.1)	3
SFPV24V SFPV24R	Vee Reg	1/8" NPT	2.00" (50.8)	1.00" (25.4)	2.44" (62.0)	4.94" (125.5)	1.19" (30.2)	1.19" (30.2)	0.62" (15.7)	0.38" (9.7)	3.00" (76.2)	0.25" (6.4)	---	---	0.75" (19.1)	4
SFPV25V SFPV25R	Vee Reg	1/8" NPT	2.00" (50.8)	1.00" (25.4)	3.38" (85.9)	8.38" (212.9)	1.68" (42.7)	1.19" (30.2)	0.62" (15.7)	0.38" (9.7)	3.00" (76.2)	0.25" (6.4)	---	---	0.75" (19.1)	5
SFPV26V SFPV26R	Vee Reg	1/8" NPT	2.00" (50.8)	1.00" (25.4)	2.25" (57.2)	4.75" (120.7)	---	1.19" (30.2)	0.62" (15.7)	0.38" (9.7)	3.00" (76.2)	0.25" (6.4)	0.75" (19.1)	0.87" (22.1)	0.75" (19.1)	6
SFPMV26V	Meter	1/8" NPT	1.37" (34.8)	0.87" (22.1)	1.56" (39.6)	4.70" (119.4)	---	0.94" (23.9)	1.19" (30.2)	0.44" (11.2)	2.37" (60.2)	0.16" (4.1)	0.62" (15.7)	0.71" (18.0)	0.75" (19.1)	7
SFPMMV26V	Micro-Meter	1/8" NPT	1.37" (34.8)	0.87" (22.1)	1.56" (39.6)	5.24" (133.1)	---	0.94" (23.9)	1.19" (30.2)	0.44" (11.2)	2.37" (60.2)	0.16" (4.1)	0.62" (15.7)	0.71" (18.0)	0.75" (19.1)	8

See page NPT-1 for orifice and Cv

**2-stem Manifold**

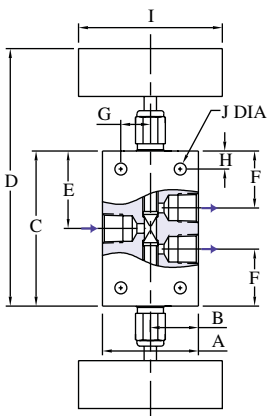

Figure 5

**Replaceable Seat**

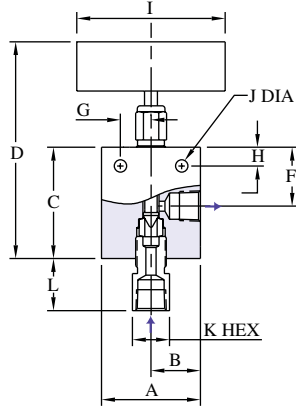

Figure 6

**Metering**

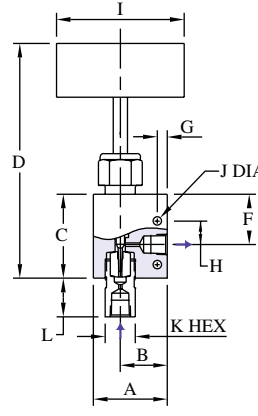

Figure 7

**Micro-Metering**

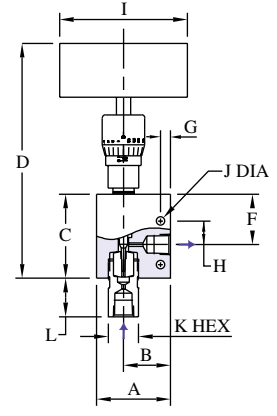

Figure 8

All dimensions are for reference only and are subject to change.  
Dimensions in parentheses are millimeters (mm)

# NEEDLE VALVES FOR 15,000 PSI (1030 BAR)

**1/8" PIPE**

**2-way Straight  
Female Ports**

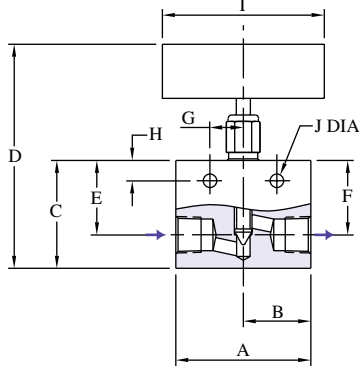

Figure 9

**2-way Straight  
Male Inlet, Female Outlet**

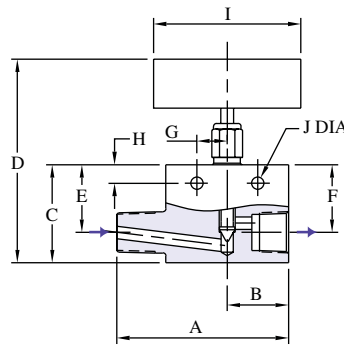

Figure 10

**2-way Angle  
Male Inlet, Female Outlet**

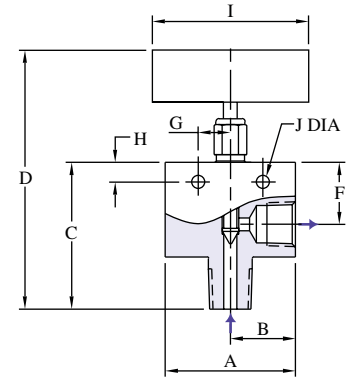

Figure 11

Catalog Number	Connection	A	B	C	D	E	F	G	H	I	J	K	L	Thk.	Fig
DHP2F	1/8" NPT	2.50" (63.5)	1.25" (31.8)	2.00" (50.8)	4.50" (114.3)	1.38" (35.1)	1.38" (35.1)	0.62" (15.7)	0.38" (9.7)	3.00" (76.2)	0.25" (6.4)	---	---	1.00" (25.4)	9
DHP2MF	1/8" NPT	3.06" (77.7)	1.25" (31.8)	2.00" (50.8)	4.50" (114.3)	1.38" (35.1)	1.38" (35.1)	0.62" (15.7)	0.38" (9.7)	3.00" (76.2)	0.25" (6.4)	---	---	1.00" (25.4)	10
DHP22MF	1/8" NPT	2.00" (50.8)	1.00" (25.4)	2.43" (61.7)	4.93" (125.2)	---	1.19" (30.2)	0.62" (15.7)	0.38" (9.7)	3.00" (76.2)	0.25" (6.4)	---	---	1.00" (25.4)	11
DHP27	1/8" NPT	5.38" (136.7)	1.50" (38.1)	2.00" (50.8)	4.50" (114.3)	1.19" (30.2)	1.19" (30.2)	0.62" (15.7)	0.38" (9.7)	3.00" (76.2)	0.25" (6.4)	2.97" (75.4)	1/8" FNPT	1.25" (31.8)	12
DHP29	1/8" NPT	6.10" (154.9)	1.25" (31.8)	1.19" (30.2)	4.50" (114.3)	2.00" (50.8)	1.19" (30.2)	0.62" (15.7)	0.38" (9.7)	3.00" (76.2)	0.25" (6.4)	2.87" (72.9)	---	1.00" (25.4)	13

See page NPT-1 for orifice and Cv

**Block & Bleed/Gauge  
Male Inlet, Female Outlet**

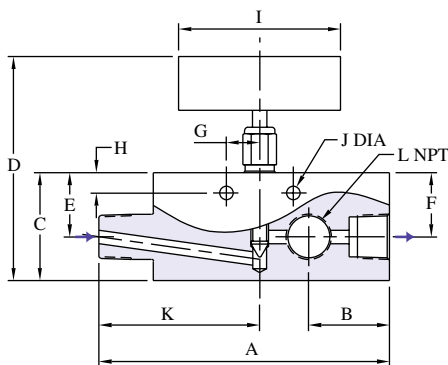

Figure 12

**Extension  
Male Inlet, Female Outlet**

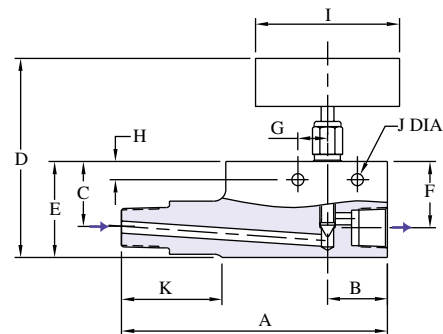

Figure 13

All dimensions are for reference only and are subject to change.  
Dimensions in parentheses are millimeters (mm)

# NEEDLE VALVES FOR 15,000 PSI (1030 BAR)

## 1/4" PIPE

**2-way Straight**

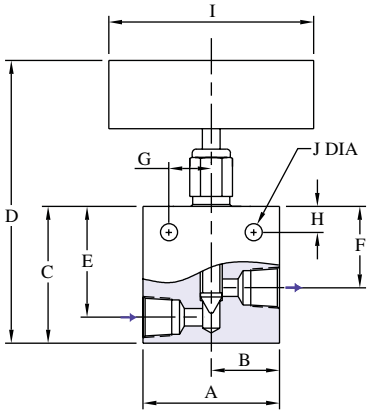

Figure 1

**2-way Angle**

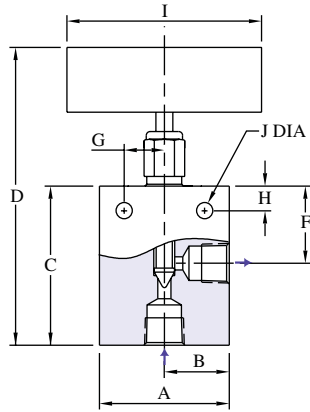

Figure 2

**3-way Two on Pressure**

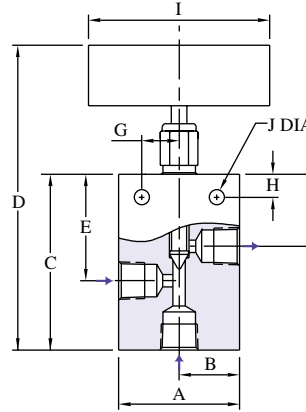

Figure 3

**3-way One on Pressure**

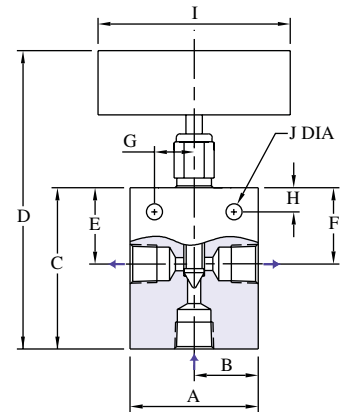

Figure 4

Catalog Number	Stem Style	Connection	A	B	C	D	E	F	G	H	I	J	K	L	Thk.	Fig
SFPV41V	Vee	1/4" NPT	2.00"	1.00"	2.00"	4.50"	1.62"	1.19"	0.62"	0.38"	3.00"	0.25"	---	---	0.75"	1
SFPV41R	Reg	1/4" NPT	(50.8)	(25.4)	(50.8)	(114.3)	(41.1)	(30.2)	(15.7)	(9.7)	(76.2)	(6.4)	---	---	(19.1)	
SFPV42V	Vee	1/4" NPT	2.00"	1.00"	2.44"	4.94"	---	1.19"	0.62"	0.38"	3.00"	0.25"	---	---	0.75"	2
SFPV42R	Reg	1/4" NPT	(50.8)	(25.4)	(62.0)	(125.5)	---	(30.2)	(15.7)	(9.7)	(76.2)	(6.4)	---	---	(19.1)	
SFPV43V	Vee	1/4" NPT	2.00"	1.00"	2.62"	5.12"	1.62"	1.19"	0.62"	0.38"	3.00"	0.25"	---	---	0.75"	3
SFPV43R	Reg	1/4" NPT	(50.8)	(25.4)	(66.5)	(130.0)	(41.1)	(30.2)	(15.7)	(9.7)	(76.2)	(6.4)	---	---	(19.1)	
SFPV44V	Vee	1/4" NPT	2.00"	1.00"	2.44"	4.94"	1.19"	1.19"	0.62"	0.38"	3.00"	0.25"	---	---	0.75"	4
SFPV44R	Reg	1/4" NPT	(50.8)	(25.4)	(62.0)	(125.5)	(30.2)	(30.2)	(15.7)	(9.7)	(76.2)	(6.4)	---	---	(19.1)	
SFPV45V	Vee	1/4" NPT	2.00"	1.00"	3.38"	8.38"	1.69"	1.19"	0.62"	0.38"	3.00"	0.25"	---	---	0.75"	5
SFPV45R	Reg	1/4" NPT	(50.8)	(25.4)	(85.9)	(212.9)	(42.9)	(30.2)	(15.7)	(9.7)	(76.2)	(6.4)	---	---	(19.1)	
SFPV46V	Vee	1/4" NPT	2.00"	1.00"	2.25"	4.75"	---	1.19"	0.62"	0.38"	3.00"	0.25"	0.75"	0.87"	0.75"	6
SFPV46R	Reg	1/4" NPT	(50.8)	(25.4)	(57.2)	(120.7)	---	(30.2)	(15.7)	(9.7)	(76.2)	(6.4)	(19.1)	(22.1)	(19.1)	
SFPMV46V	Meter	1/4" NPT	2.50"	1.25"	2.62"	5.66"	---	1.31"	0.69"	0.38"	3.00"	0.25"	0.75"	1.02"	1.00"	7
SFPMV46R	Reg	1/4" NPT	(63.5)	(31.8)	(66.5)	(143.8)	---	(33.3)	(17.5)	(9.7)	(76.2)	(6.4)	(19.1)	(25.9)	(25.4)	
SFPMMV46V	Micro-Meter	1/4" NPT	2.50"	1.25"	2.62"	6.30"	---	1.31"	0.69"	0.38"	2.35"	0.25"	0.75"	1.02"	1.00"	8
SFPMMV46R	Reg	1/4" NPT	(63.5)	(31.8)	(66.5)	(160.0)	---	(33.3)	(17.5)	(9.7)	(59.7)	(6.4)	(19.1)	(25.9)	(25.4)	

See page NPT-1 for orifice and Cv

**2-stem Manifold**

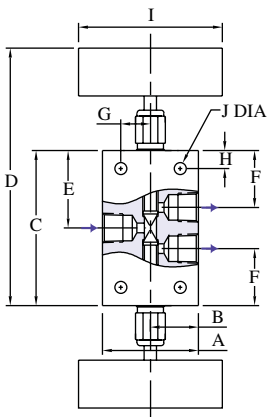

Figure 5

**Replaceable Seat**

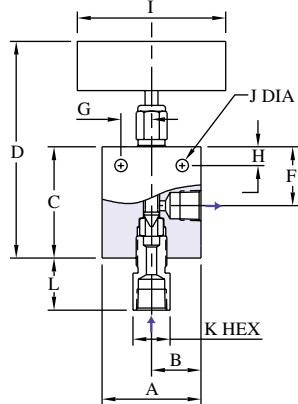

Figure 6

**Metering**

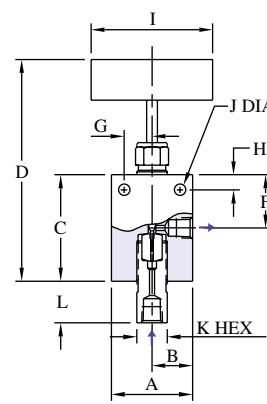

Figure 7

**Micro-Metering**

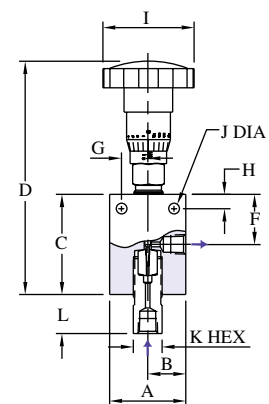

Figure 8

# NEEDLE VALVES FOR 15,000 PSI (1030 BAR)

1/4" PIPE

**2-way Straight  
Female Ports**

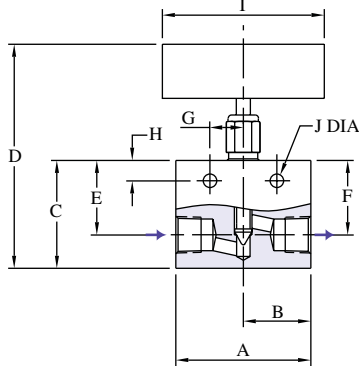

Figure 9

**2-way Straight  
Male Inlet, Female Outlet**

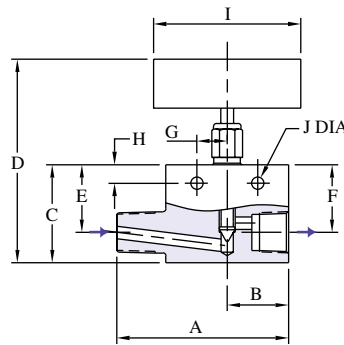

Figure 10

**2-way Angle  
Male Inlet, Female Outlet**

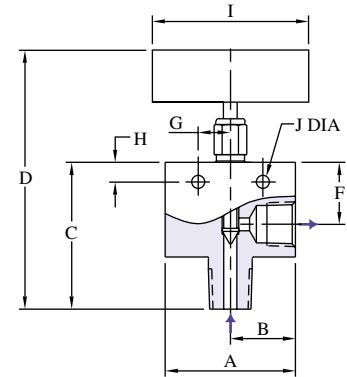

Figure 11

Catalog Number	Connection	A	B	C	D	E	F	G	H	I	J	K	L	Thk.	Fig
DHP4F	1/4" NPT	2.50" (63.5)	1.25" (31.8)	2.00" (50.8)	4.50" (114.3)	1.38" (35.1)	1.38" (35.1)	0.62" (15.7)	0.38" (9.7)	3.00" (76.2)	0.25" (6.4)	---	---	1.00" (25.4)	9
DHP4MF	1/4" NPT	3.50" (88.9)	1.25" (31.8)	2.00" (50.8)	4.50" (114.3)	1.38" (35.1)	1.38" (35.1)	0.62" (15.7)	0.38" (9.7)	3.00" (76.2)	0.25" (6.4)	---	---	1.00" (25.4)	10
DHP42MF	1/4" NPT	2.00" (50.8)	1.00" (25.4)	2.43" (61.7)	4.93" (125.2)	---	1.19" (30.2)	0.62" (15.7)	0.38" (9.7)	3.00" (76.2)	0.25" (6.4)	---	---	1.00" (25.4)	11
DHP47	1/4" NPT	4.50" (114.3)	1.34" (34.0)	2.00" (50.8)	4.50" (114.3)	1.37" (34.8)	1.37" (34.8)	0.62" (15.7)	0.38" (9.7)	3.00" (76.2)	0.25" (6.4)	2.25" (57.2)	1/4" FNPT	1.25" (31.8)	12
DHP49	1/4" NPT	6.10" (154.9)	1.25" (31.8)	2.00" (50.8)	4.50" (114.3)	1.19" (30.2)	1.19" (30.2)	0.62" (15.7)	0.38" (9.7)	3.00" (76.2)	0.25" (6.4)	2.87" (72.9)	---	1.00" (25.4)	13

See page NPT-1 for orifice and Cv

**Block & Bleed/Gauge  
Male Inlet, Female Outlet**

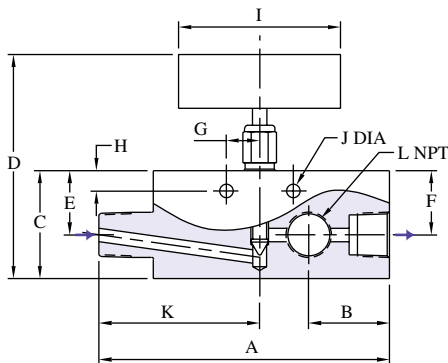

Figure 12

**Extension  
Male Inlet, Female Outlet**

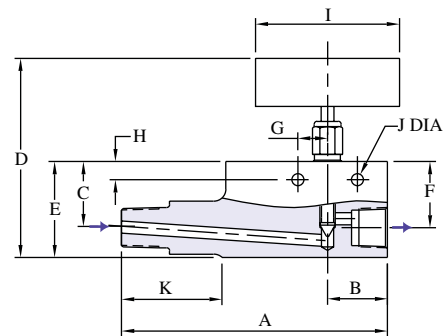

Figure 13

All dimensions are for reference only and are subject to change.  
Dimensions in parentheses are millimeters (mm)



# NEEDLE VALVES FOR 15,000 PSI (1030 BAR)

## 3/8" PIPE

**2-way Straight**

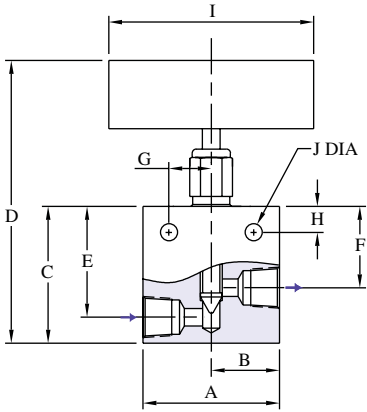

Figure 1

**2-way Angle**

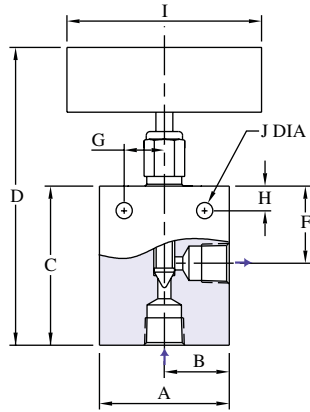

Figure 2

**3-way Two on Pressure**

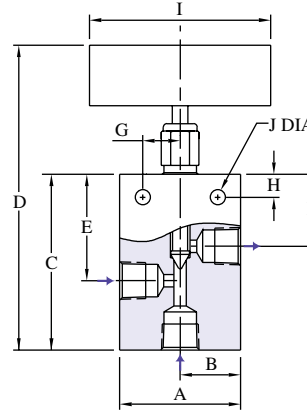

Figure 3

**3-way One on Pressure**

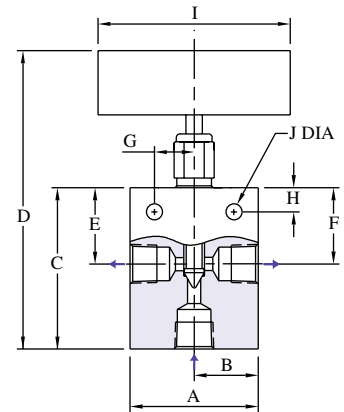

Figure 4

Catalog Number	Stem Style	Connection	A	B	C	D	E	F	G	H	I	J	K	L	Thk.	Fig
SFPV61V	Vee	3/8" NPT	2.50"	1.25"	2.88"	6.32"	2.38"	1.75"	0.69"	0.50"	4.00"	0.34"	---	---	1.00"	1
SFPV61R	Reg	3/8" NPT	(63.5)	(31.8)	(73.2)	(160.5)	(60.5)	(44.5)	(17.5)	(12.7)	(101.6)	(8.6)	---	---	(25.4)	
SFPV62V	Vee	3/8" NPT	2.50"	1.25"	3.38"	6.82"	---	1.75"	0.69"	0.50"	4.00"	0.34"	---	---	1.00"	2
SFPV62R	Reg	3/8" NPT	(63.5)	(31.8)	(85.9)	(173.2)	---	(44.5)	(17.5)	(12.7)	(101.6)	(8.6)	---	---	(25.4)	
SFPV63V	Vee	3/8" NPT	2.50"	1.25"	3.62"	7.06"	2.38"	1.75"	0.69"	0.50"	4.00"	0.34"	---	---	1.00"	3
SFPV63R	Reg	3/8" NPT	(63.5)	(31.8)	(91.9)	(179.3)	(60.5)	(44.5)	(17.5)	(12.7)	(101.6)	(8.6)	---	---	(25.4)	
SFPV64V	Vee	3/8" NPT	2.50"	1.25"	3.38"	6.82"	1.75"	1.75"	0.69"	0.50"	4.00"	0.34"	---	---	1.00"	4
SFPV64R	Reg	3/8" NPT	(63.5)	(31.8)	(85.9)	(173.2)	(44.5)	(44.5)	(17.5)	(12.7)	(101.6)	(8.6)	---	---	(25.4)	
SFPV65V	Vee	3/8" NPT	2.50"	1.25"	5.12"	12.00"	2.56"	1.75"	0.69"	0.50"	4.00"	0.34"	---	---	1.00"	5
SFPV65R	Reg	3/8" NPT	(63.5)	(31.8)	(130.0)	(304.8)	(65.0)	(44.5)	(17.5)	(12.7)	(101.6)	(8.6)	---	---	(25.4)	
SFPV66V	Vee	3/8" NPT	2.50"	1.25"	3.25"	6.69"	---	1.75"	0.69"	0.50"	4.00"	0.34"	1.00"	1.22"	1.00"	6
SFPV66R	Reg	3/8" NPT	(63.5)	(31.8)	(82.6)	(169.9)	---	(44.5)	(17.5)	(12.7)	(101.6)	(8.6)	(25.4)	(31.0)	(25.4)	
SFPMV66V	Meter	3/8" NPT	2.50"	1.25"	2.62"	5.66"	---	1.31"	0.69"	0.38"	4.00"	0.25"	1.00"	1.12"	1.00"	7
SFPMV66R	Micro-Meter	3/8" NPT	(63.5)	(31.8)	(66.5)	(143.8)	---	(33.3)	(17.5)	(9.7)	(101.6)	(6.4)	(25.4)	(28.4)	(25.4)	
SFPMMV66V	Micro-Meter	3/8" NPT	2.50"	1.25"	2.62"	6.30"	---	1.31"	0.69"	0.38"	2.35"	0.25"	1.00"	1.12"	1.00"	8
SFPMMV66R	Micro-Meter	3/8" NPT	(63.5)	(31.8)	(66.5)	(160.0)	---	(33.3)	(17.5)	(9.7)	(59.7)	(6.4)	(25.4)	(28.4)	(25.4)	

See page NPT-1 for orifice and Cv

**2-stem Manifold**

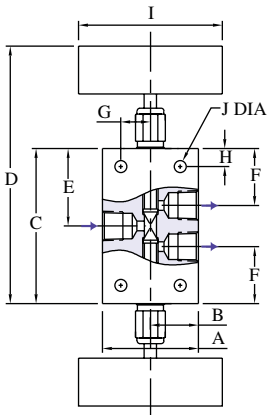

Figure 5

**Replaceable Seat**

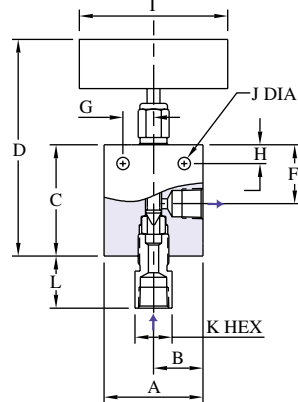

Figure 6

**Metering**

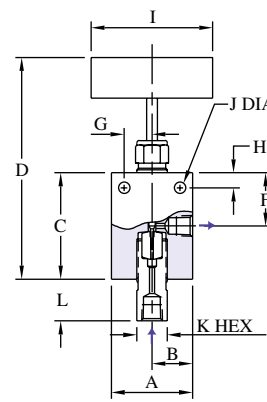

Figure 7

**Micro-Metering**

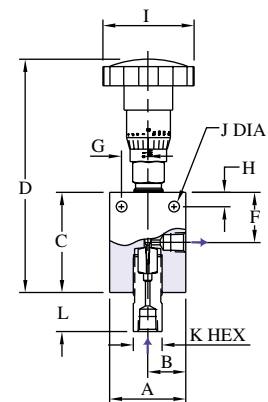

Figure 8



# NEEDLE VALVES FOR 15,000 PSI (1030 BAR)

**3/8" PIPE**

**2-way Straight  
Female Ports**

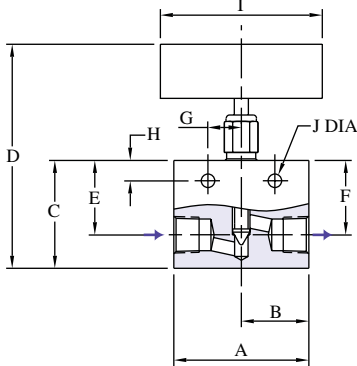

Figure 9

**2-way Straight  
Male Inlet, Female Outlet**

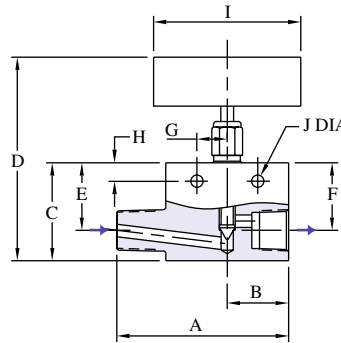

Figure 10

**2-way Angle  
Male Inlet, Female Outlet**

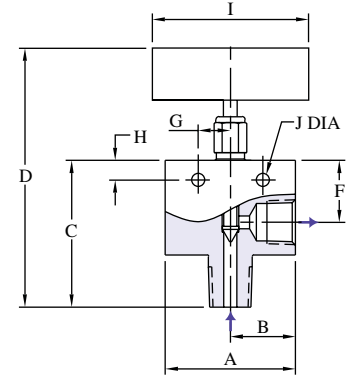

Figure 11

Catalog Number	Connection	A	B	C	D	E	F	G	H	I	J	K	L	Thk.	Fig
DHP6F	3/8" NPT	2.50" (63.5)	1.25" (31.8)	2.00" (50.8)	4.50" (114.3)	1.38" (35.1)	1.38" (35.1)	0.62" (15.7)	0.38" (9.7)	3.00" (76.2)	0.25" (6.4)	---	---	1.00" (25.4)	9
DHP6MF	3/8" NPT	3.50" (88.9)	1.25" (31.8)	2.00" (50.8)	4.50" (114.3)	1.38" (35.1)	1.38" (35.1)	0.62" (15.7)	0.38" (9.7)	3.00" (76.2)	0.25" (6.4)	---	---	1.00" (25.4)	10
DHP62MF	3/8" NPT	2.50" (63.5)	1.25" (31.8)	2.43" (61.7)	4.93" (125.2)	---	1.19" (30.2)	0.62" (15.7)	0.38" (9.7)	3.00" (76.2)	0.25" (6.4)	---	---	1.00" (25.4)	11
DHP67	3/8" NPT	5.38" (136.7)	1.50" (38.1)	2.00" (50.8)	4.50" (114.3)	1.19" (30.2)	1.19" (30.2)	0.62" (15.7)	0.38" (9.7)	3.00" (76.2)	0.25" (6.4)	2.97" (75.4)	3/8" FNPT	1.25" (31.8)	12
DHP69	3/8" NPT	6.10" (154.9)	1.25" (31.8)	2.00" (50.8)	4.50" (114.3)	1.19" (30.2)	1.19" (30.2)	0.62" (15.7)	0.38" (9.7)	3.00" (76.2)	0.25" (6.4)	2.87" (72.9)	---	1.00" (25.4)	13

See page NPT-1 for orifice and Cv

**Block & Bleed/Gauge  
Male Inlet, Female Outlet**

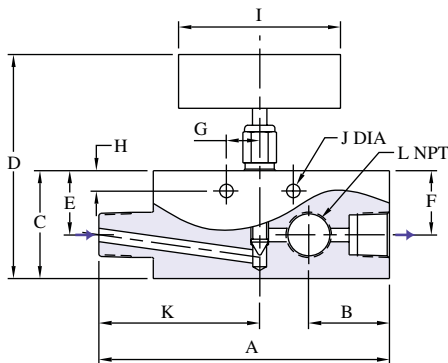

Figure 12

**Extension  
Male Inlet, Female Outlet**

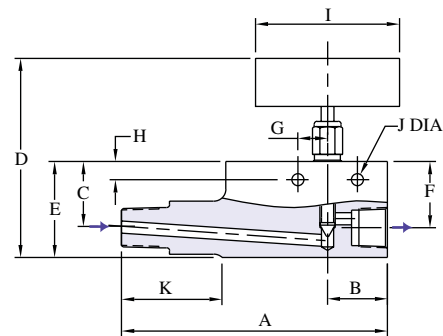

Figure 13

All dimensions are for reference only and are subject to change.  
Dimensions in parentheses are millimeters (mm)

# NEEDLE VALVES FOR 15,000 PSI (1030 BAR)

## 1/2" PIPE

### 2-way Straight

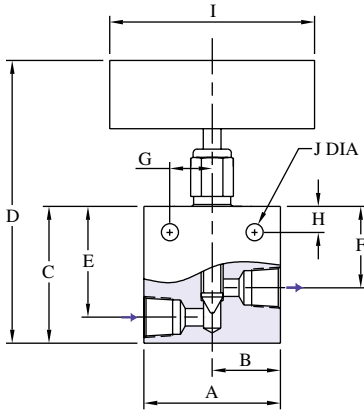

Figure 1

### 2-way Angle

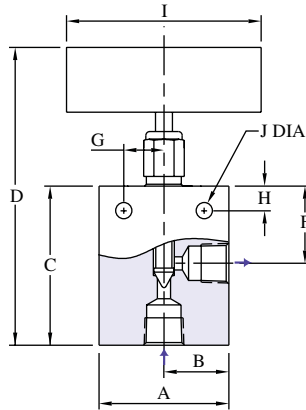

Figure 2

### 3-way Two on Pressure

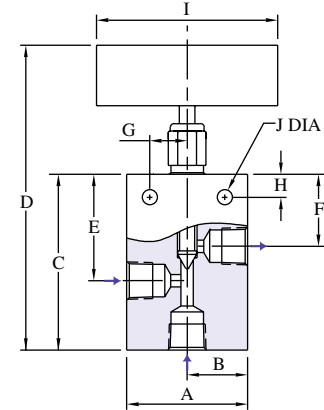

Figure 3

Catalog Number	Stem Style	Connection	A	B	C	D	E	F	G	H	I	J	K	L	Thk.	Fig
SFPV81V	Vee	1/2" NPT	2.50"	1.25"	3.00"	6.44"	2.38"	1.75"	0.69"	0.50"	4.00"	0.34"	---	---	1.25"	1
SFPV81R	Reg	1/2" NPT	(63.5)	(31.8)	(76.2)	(163.6)	(60.5)	(44.5)	(17.5)	(12.7)	(101.6)	(8.6)	---	---	(31.8)	
SFPV82V	Vee	1/2" NPT	2.50"	1.25"	3.38"	6.82"	---	1.75"	0.69"	0.50"	4.00"	0.34"	---	---	1.25"	2
SFPV82R	Reg	1/2" NPT	(63.5)	(31.8)	(85.9)	(173.2)	---	(44.5)	(17.5)	(12.7)	(101.6)	(8.6)	---	---	(31.8)	
SFPV83V	Vee	1/2" NPT	2.50"	1.25"	3.62"	7.06"	2.38"	1.75"	0.69"	0.50"	4.00"	0.34"	---	---	1.25"	3
SFPV83R	Reg	1/2" NPT	(63.5)	(31.8)	(91.9)	(179.3)	(60.5)	(44.5)	(17.5)	(12.7)	(101.6)	(8.6)	---	---	(31.8)	
SFPV84V	Vee	1/2" NPT	2.50"	1.25"	3.38"	6.44"	1.75"	1.75"	0.69"	0.50"	4.00"	0.34"	---	---	1.25"	4
SFPV84R	Reg	1/2" NPT	(63.5)	(31.8)	(85.9)	(163.6)	(44.5)	(44.5)	(17.5)	(12.7)	(101.6)	(8.6)	---	---	(31.8)	
SFPV85V	Vee	1/2" NPT	2.50"	1.25"	5.12"	12.00"	2.56"	1.75"	0.69"	0.50"	4.00"	0.34"	---	---	1.25"	5
SFPV85R	Reg	1/2" NPT	(63.5)	(31.8)	(130.0)	(304.8)	(65.0)	(44.5)	(17.5)	(12.7)	(101.6)	(8.6)	---	---	(31.8)	
SFPV86V	Vee	1/2" NPT	2.50"	1.25"	3.25"	6.69"	---	1.75"	0.69"	0.50"	4.00"	0.34"	1.38"	1.00"	1.25"	6
SFPV86R	Reg	1/2" NPT	(63.5)	(31.8)	(82.6)	(169.9)	---	(44.5)	(17.5)	(12.7)	(101.6)	(8.6)	(35.1)	(25.4)	(31.8)	

See page NPT-1 for orifice and Cv

### 3-way One on Pressure

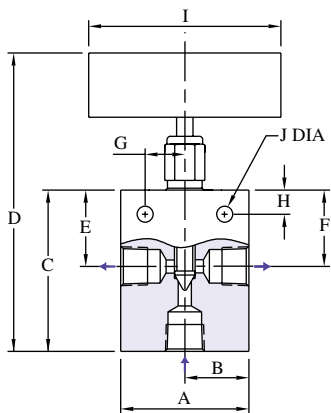

Figure 4

### 2-stem Manifold

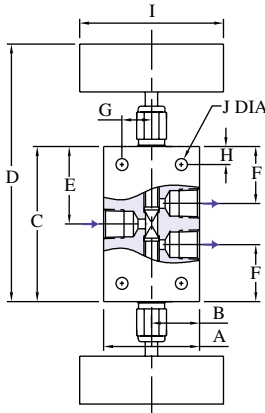

Figure 5

### Replaceable Seat

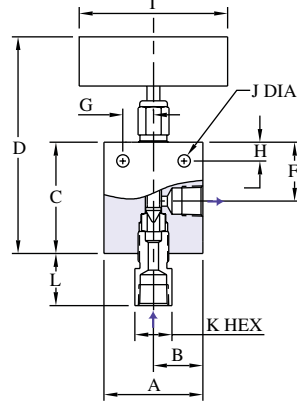

Figure 6

# NEEDLE VALVES FOR 15,000 PSI (1030 BAR)

1/2" PIPE

**2-way Straight  
Female Ports**

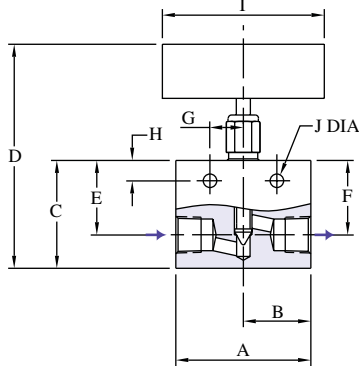

Figure 7

**2-way Straight  
Male Inlet, Female Outlet**

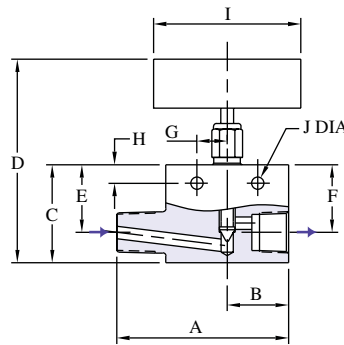

Figure 8

**2-way Angle  
Male Inlet, Female Outlet**

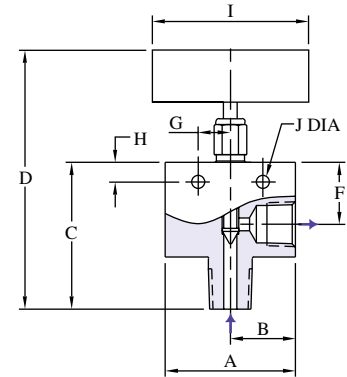

Figure 9

Catalog Number	Connection	A	B	C	D	E	F	G	H	I	J	K	L	Thk.	Fig
DHP8F	1/2" NPT	2.50" (63.5)	1.25" (31.8)	2.00" (50.8)	4.50" (114.3)	1.38" (35.1)	1.38" (35.1)	0.62" (15.7)	0.38" (9.7)	3.00" (76.2)	0.25" (6.4)	---	---	1.25" (31.8)	7
DHP8MF	1/2" NPT	3.50" (88.9)	1.25" (31.8)	2.00" (50.8)	4.50" (114.3)	1.38" (35.1)	1.38" (35.1)	0.62" (15.7)	0.38" (9.7)	3.00" (76.2)	0.25" (6.4)	---	---	1.25" (31.8)	8
DHP82MF	1/2" NPT	2.50" (63.5)	1.25" (31.8)	2.81" (71.4)	5.31" (134.9)	---	1.19" (30.2)	0.62" (15.7)	0.38" (9.7)	3.00" (76.2)	0.25" (6.4)	---	---	1.25" (31.8)	9
DHP87	1/2" NPT	5.38" (136.7)	1.50" (38.1)	2.00" (50.8)	4.50" (114.3)	1.19" (30.2)	1.19" (30.2)	0.62" (15.7)	0.38" (9.7)	3.00" (76.2)	0.25" (6.4)	2.97" (75.4)	1/2" FNPT	1.25" (31.8)	10
DHP89	1/2" NPT	6.10" (154.9)	1.25" (31.8)	2.00" (50.8)	4.50" (114.3)	1.19" (30.2)	1.19" (30.2)	0.62" (15.7)	0.38" (9.7)	3.00" (76.2)	0.25" (6.4)	2.87" (72.9)	---	1.25" (31.8)	11

See page NPT-1 for orifice and Cv

**Block & Bleed/Gauge  
Male Inlet, Female Outlet**

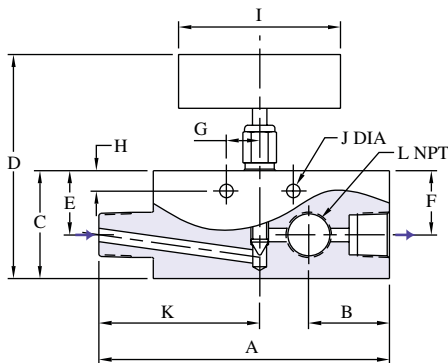

Figure 10

**Extension  
Male Inlet, Female Outlet**

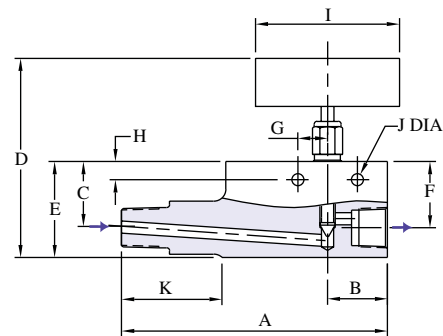

Figure 11

All dimensions are for reference only and are subject to change.  
Dimensions in parentheses are millimeters (mm)

# NEEDLE VALVES FOR 10,000 PSI (690 BAR)

## 3/4" PIPE

### 2-way Straight

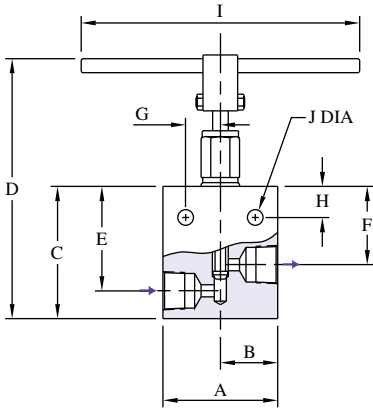

Figure 1

### 2-way Angle

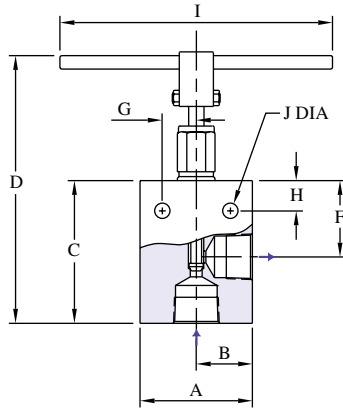

Figure 2

### 3-way Two on Pressure

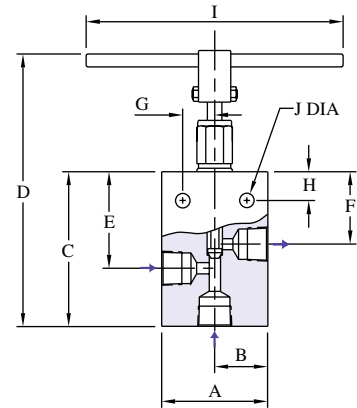

Figure 3

Catalog Number	Stem Style	Connection	A	B	C	D	E	F	G	H	I	J	K	L	Thk.	Fig
FPV121V	Vee	3/4" NPT	4.12"	2.06"	5.50"	10.94"	3.75"	2.81"	1.25"	1.12"	10.00"	0.56"	---	---	1.75"	1
FPV121R	Reg	3/4" NPT	(104.6)	(52.3)	(139.7)	(277.9)	(95.3)	(71.4)	(31.8)	(28.4)	(254.0)	(14.2)	---	---	(44.5)	
FPV122V	Vee	3/4" NPT	4.12"	2.06"	5.50"	10.94"	---	2.81"	1.25"	1.12"	10.00"	0.56"	---	---	1.75"	2
FPV122R	Reg	3/4" NPT	(104.6)	(52.3)	(139.7)	(277.9)	---	(71.4)	(31.8)	(28.4)	(254.0)	(14.2)	---	---	(44.5)	
FPV123V	Vee	3/4" NPT	4.12"	2.06"	5.50"	10.94"	3.75"	2.81"	1.25"	1.12"	10.00"	0.56"	---	---	1.75"	3
FPV123R	Reg	3/4" NPT	(104.6)	(52.3)	(139.7)	(277.9)	(95.3)	(71.4)	(31.8)	(28.4)	(254.0)	(14.2)	---	---	(44.5)	
FPV124V	Vee	3/4" NPT	4.12"	2.06"	5.50"	10.94"	2.81"	2.81"	1.25"	1.12"	10.00"	0.56"	---	---	1.75"	4
FPV124R	Reg	3/4" NPT	(104.6)	(52.3)	(139.7)	(277.9)	(71.4)	(71.4)	(31.8)	(28.4)	(254.0)	(14.2)	---	---	(44.5)	
FPV125V	Vee	3/4" NPT	4.12"	2.06"	8.00"	18.88"	4.00"	2.81"	1.25"	1.12"	10.00"	0.56"	---	---	1.75"	5
FPV125R	Reg	3/4" NPT	(104.6)	(52.3)	(203.2)	(479.6)	(101.6)	(71.4)	(31.8)	(28.4)	(254.0)	(14.2)	---	---	(44.5)	
FPV126V	Vee	3/4" NPT	4.12"	2.06"	4.81"	10.25"	---	2.81"	1.25"	1.12"	10.00"	0.56"	1.75"	1.75"	1.75"	6
FPV126R	Reg	3/4" NPT	(104.6)	(52.3)	(122.2)	(260.4)	---	(71.4)	(31.8)	(28.4)	(254.0)	(14.2)	(44.5)	(44.5)	(44.5)	

See page NPT-1 for orifice and Cv

### 3-way One on Pressure

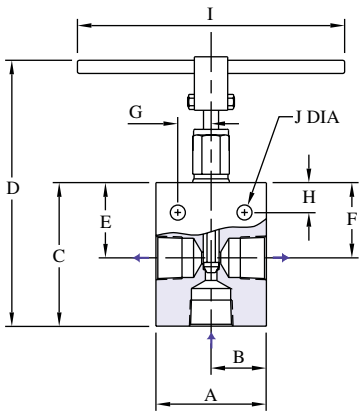

Figure 4

### 2-stem Manifold

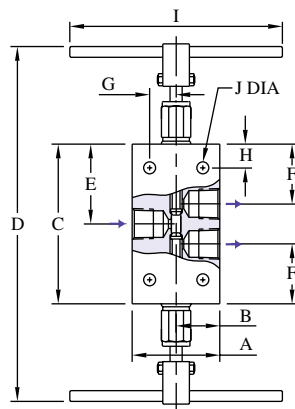

Figure 5

### Replaceable Seat

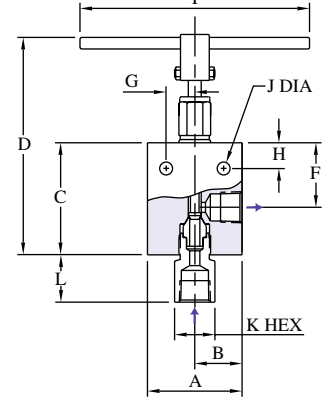

Figure 6

# NEEDLE VALVES FOR 10,000 PSI (690 BAR)

**3/4" PIPE**

**2-way Straight  
Female Ports**

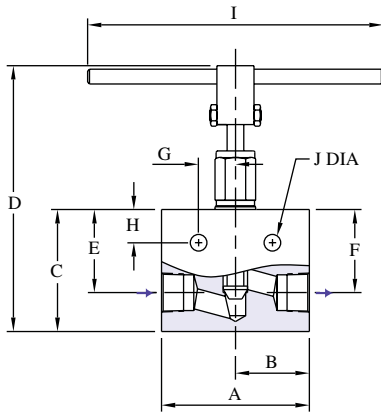

Figure 7

**2-way Straight  
Male Inlet, Female Outlet**

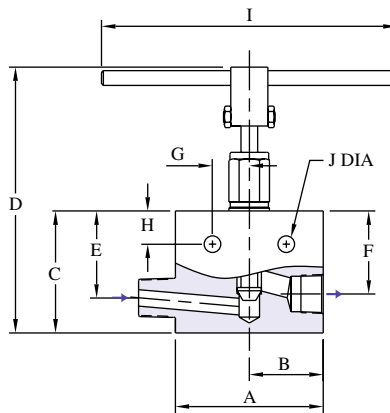

Figure 8

**2-way Angle  
Male Inlet, Female Outlet**

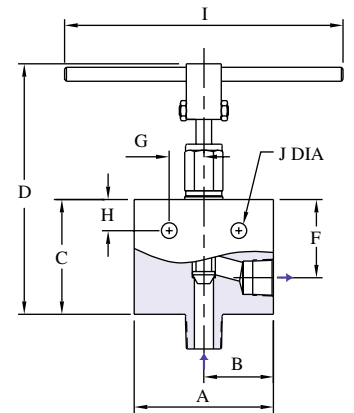

Figure 9

Catalog Number	Connection	A	B	C	D	E	F	G	H	I	J	Thk.	Fig
DHP12F	3/4" NPT	5.00" (127.0)	2.50" (63.5)	4.12" (104.6)	9.56" (242.8)	2.81" (71.4)	2.81" (71.4)	1.25" (31.8)	1.12" (28.4)	10.00" (254.0)	0.56" (14.2)	1.75" (44.5)	7
DHP12MF	3/4" NPT	6.00" (152.4)	2.50" (63.5)	4.12" (104.6)	9.56" (242.8)	2.81" (71.4)	2.81" (71.4)	1.25" (31.8)	1.12" (28.4)	10.00" (254.0)	0.56" (14.2)	1.75" (44.5)	8
DHP122MF	3/4" NPT	4.12" (104.6)	2.06" (52.3)	4.25" (108.0)	9.56" (242.8)	---	2.36" (59.9)	1.25" (31.8)	1.12" (28.4)	10.00" (254.0)	0.56" (14.2)	1.75" (44.5)	9

See page NPT-1 for orifice and Cv

All dimensions are for reference only and are subject to change.  
Dimensions in parentheses are millimeters (mm)

# NEEDLE VALVES FOR 10,000 PSI (690 BAR)

## 1" PIPE

### 2-way Straight

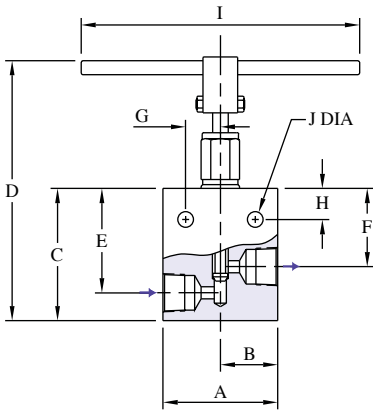

Figure 1

### 2-way Angle

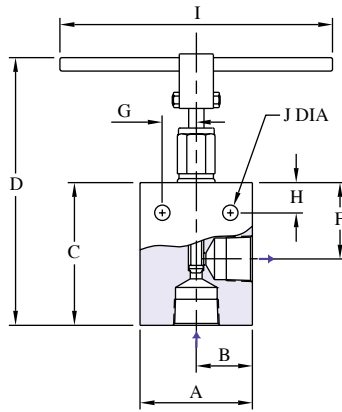

Figure 2

### 3-way Two on Pressure

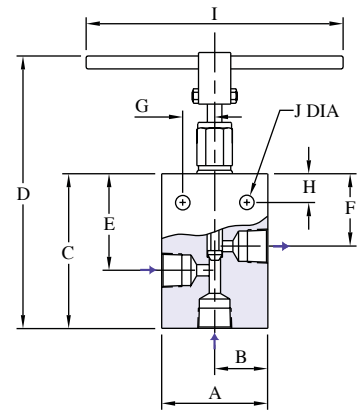

Figure 3

Catalog Number	Stem Style	Connection	A	B	C	D	E	F	G	H	I	J	K	L	Thk.	Fig
FPV161V	Vee	1" NPT	4.12"	2.06"	5.50"	10.94"	3.75"	2.81"	1.25"	1.12"	10.00"	0.56"	---	---	1.75"	1
FPV161R	Reg	1" NPT	(104.6)	(52.3)	(139.7)	(277.9)	(95.3)	(71.4)	(31.8)	(28.4)	(254.0)	(14.2)	---	---	(44.5)	
FPV162V	Vee	1" NPT	4.12"	2.06"	5.50"	10.94"	---	2.81"	1.25"	1.12"	10.00"	0.56"	---	---	1.75"	2
FPV162R	Reg	1" NPT	(104.6)	(52.3)	(139.7)	(277.9)	---	(71.4)	(31.8)	(28.4)	(254.0)	(14.2)	---	---	(44.5)	
FPV163V	Vee	1" NPT	4.12"	2.06"	5.75"	11.19"	3.75"	2.81"	1.25"	1.12"	10.00"	0.56"	---	---	1.75"	3
FPV163R	Reg	1" NPT	(104.6)	(52.3)	(146.1)	(284.2)	(95.3)	(71.4)	(31.8)	(28.4)	(254.0)	(14.2)	---	---	(44.5)	
FPV164V	Vee	1" NPT	4.12"	2.06"	5.50"	10.94"	2.81"	2.81"	1.25"	1.12"	10.00"	0.56"	---	---	1.75"	4
FPV164R	Reg	1" NPT	(104.6)	(52.3)	(139.7)	(277.9)	(71.4)	(71.4)	(31.8)	(28.4)	(254.0)	(14.2)	---	---	(44.5)	
FPV165V	Vee	1" NPT	4.12"	2.06"	8.00"	18.88"	4.00"	2.81"	1.25"	1.12"	10.00"	0.56"	---	---	1.75"	5
FPV165R	Reg	1" NPT	(104.6)	(52.3)	(203.2)	(479.6)	(101.6)	(71.4)	(31.8)	(28.4)	(254.0)	(14.2)	---	---	(44.5)	
FPV166V	Vee	1" NPT	4.12"	2.06"	4.81"	11.36"	---	2.81"	1.25"	1.12"	10.00"	0.56"	1.75"	2.08"	1.75"	6
FPV166R	Reg	1" NPT	(104.6)	(52.3)	(122.2)	(288.5)	---	(71.4)	(31.8)	(28.4)	(254.0)	(14.2)	(44.5)	(52.8)	(44.5)	

See page NPT-1 for orifice and Cv

### 3-way One on Pressure

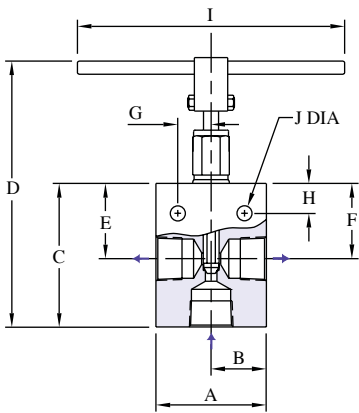

Figure 4

### 2-stem Manifold

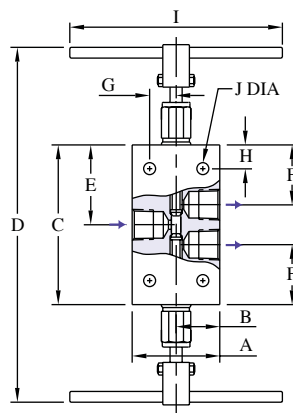

Figure 5

### Replaceable Seat

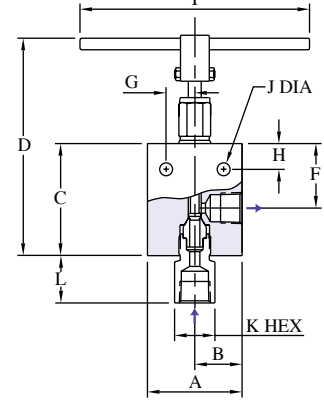

Figure 6

# NEEDLE VALVES FOR 10,000 PSI (690 BAR)

1" PIPE

2-way Straight  
Female Ports

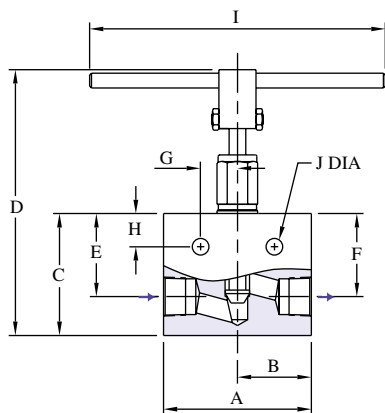

Figure8

2-way Straight  
Male Inlet, Female Outlet

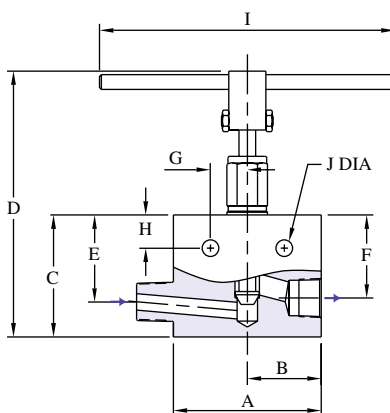

Figure 8

2-way Angle  
Male Inlet, Female Outlet

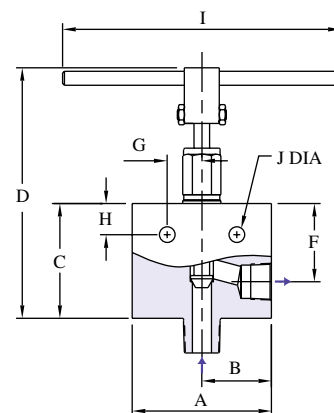

Figure9

Catalog Number	Connection	A	B	C	D	E	F	G	H	I	J	Thk.	Fig
DHP16F	1" NPT	5.00" (127.0)	2.50" (63.5)	4.12" (104.6)	9.56" (242.8)	2.81" (71.4)	2.81" (71.4)	1.25" (31.8)	1.12" (28.4)	10.00" (254.0)	0.56" (14.2)	1.75" (44.5)	7
DHP16MF	1" NPT	6.25" (158.8)	2.50" (63.5)	4.12" (104.6)	9.56" (242.8)	2.94" (74.7)	2.94" (74.7)	1.25" (31.8)	1.12" (28.4)	10.00" (254.0)	0.56" (14.2)	1.75" (44.5)	8
DHP162MF	1" NPT	4.12" (104.6)	2.06" (52.3)	4.50" (114.3)	9.94" (252.5)	---	2.36" (59.9)	1.25" (31.8)	1.12" (28.4)	10.00" (254.0)	0.56" (14.2)	1.75" (44.5)	9

See page NPT-1 for orifice and Cv

All dimensions are for reference only and are subject to change.  
Dimensions in parentheses are millimeters (mm)



# 3- AND 5-STEM MANIFOLD VALVES

Three and Five-valve manifolds are used for applications requiring multiple ports for pressure testing and line sampling. BuTech can custom design manifolds to meet your specific requirements. Our manifolds are engineered with the same expertise, quality features and options found in all of our valves. For complete details, please consult the factory.

## **Features:**

- Non-rotating stem prevents galling and scoring
  - Vee
  - Metering
  - Regulating
  - Micro-Metering
  - Soft Tip
- 17-4PH Stem for longer service life. 316 wetted parts are also available by specifying option **-316WP** (see page NPT-3)
- Low operating torque
- Pressures to 10,000 PSI (690 bar)
- 1/2" FNPT connections standard
- Standard body material: 316 stainless steel. Exotic materials available on request
- Available in Pipe-to-Pipe or Instrument Flange Mounting

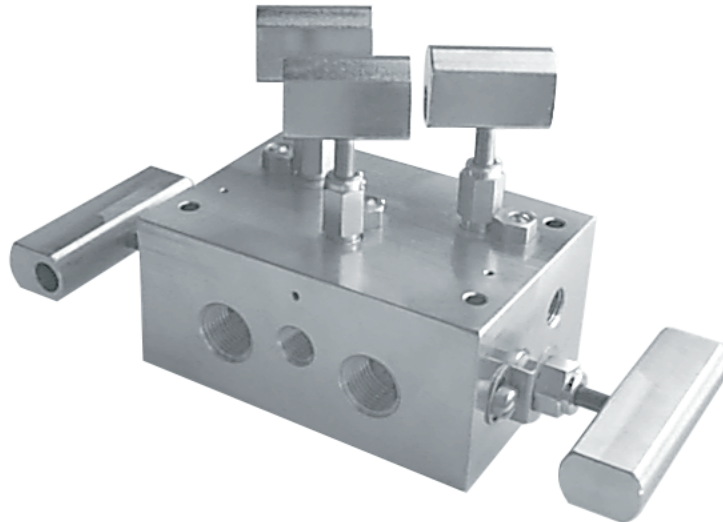

# REPLACEABLE SEAT VALVES

## Soft Seat

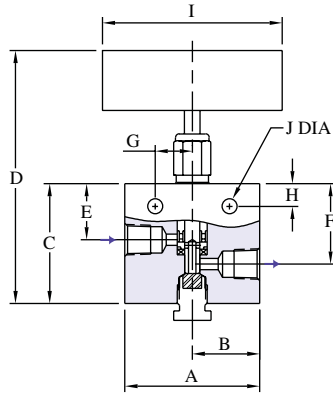

- Designed to permit replacement of the seat without removing the valve from the system.
- Non-rotating stem
- Shut-off and metering service capability
- Glass-filled PTFE Packing
- PEEK seat standard, PTFE, Torlon, Delrin, UHMWPE and other materials available

Catalog Number	Connection	A	B	C	D	E	F	G	H	I	J	Thk.
JSV-P2	1/8" NPT	2.25" (57.2)	1.12" (28.4)	2.00" (50.8)	4.34" (110.2)	0.94" (23.9)	1.34" (34.0)	0.62" (15.7)	0.38" (9.7)	3.00" (76.2)	0.25" (6.4)	0.75" (19.1)
JSV-P4	1/4" NPT	2.25" (57.2)	1.12" (28.4)	2.00" (50.8)	4.34" (110.2)	0.94" (23.9)	1.34" (34.0)	0.62" (15.7)	0.38" (9.7)	3.00" (76.2)	0.25" (6.4)	0.75" (19.1)
JSV-P6	3/8" NPT	2.25" (57.2)	1.12" (28.4)	2.00" (50.8)	4.34" (110.2)	0.94" (23.9)	1.34" (34.0)	0.62" (15.7)	0.38" (9.7)	3.00" (76.2)	0.25" (6.4)	1.00" (25.4)
JSV-P8	1/2" NPT	2.50" (63.5)	1.25" (31.8)	3.12" (79.2)	6.60" (167.6)	1.35" (34.3)	2.00" (50.8)	0.69" (17.5)	0.50" (12.7)	3.00" (76.2)	0.34" (8.6)	1.25" (31.8)

## Ball Seat

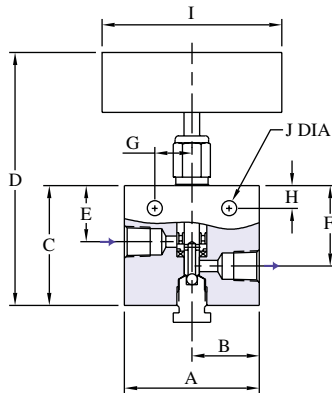

- Designed to permit replacement of the seat without removing the valve from the system
- Non-rotating stem
- Shut-off and metering service capability
- Glass-filled PTFE Packing
- 316SS seat standard, Stellite, Brass, and all other machineable materials available

Catalog Number	Connection	A	B	C	D	E	F	G	H	I	J	Thk.
JBV-P2	1/8" NPT	2.25" (57.2)	1.12" (28.4)	2.00" (50.8)	4.34" (110.2)	0.94" (23.9)	1.34" (34.0)	0.62" (15.7)	0.38" (9.7)	3.00" (76.2)	0.25" (6.4)	0.75" (19.1)
JBV-P4	1/4" NPT	2.25" (57.2)	1.12" (28.4)	2.00" (50.8)	4.34" (110.2)	0.94" (23.9)	1.34" (34.0)	0.62" (15.7)	0.38" (9.7)	3.00" (76.2)	0.25" (6.4)	0.75" (19.1)
JBV-P6	3/8" NPT	2.25" (57.2)	1.12" (28.4)	2.00" (50.8)	4.34" (110.2)	0.94" (23.9)	1.34" (34.0)	0.62" (15.7)	0.38" (9.7)	3.00" (76.2)	0.25" (6.4)	1.00" (25.4)
JBV-P8	1/2" NPT	2.50" (63.5)	1.25" (31.8)	3.12" (79.2)	6.62" (168.1)	1.35" (34.3)	2.00" (50.8)	0.69" (17.5)	0.50" (12.7)	3.00" (76.2)	0.34" (8.6)	1.25" (31.8)

All dimensions are for reference only and are subject to change.  
Dimensions in parentheses are millimeters (mm)

# PIPE ELBOWS

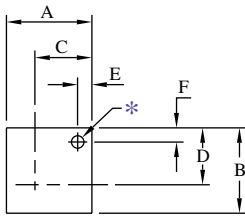

Female Elbow

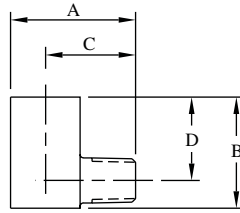

Street Elbow

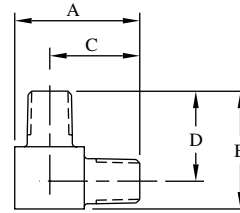

Male Elbow

## FEMALE ELBOW

Catalog Number	Connection	Port	MAWP	A	B	C	D	Block Thickness	Mounting Holes*		
									E	F	Dia.
FPL2	1/8" NPT	0.187" (4.7)	15,000 PSI 1030 bar	1.13" (28.7)	1.00" (25.4)	0.75" (19.1)	0.62" (15.7)	0.62" (15.7)	0.25" (6.4)	0.20" (5.1)	0.22" (5.6)
FPL4	1/4" NPT	0.250" (6.4)	15,000 PSI 1030 bar	1.50" (38.1)	1.25" (31.8)	1.00" (25.4)	0.81" (20.6)	0.75" (19.1)	0.38" (9.7)	0.25" (6.4)	0.22" (5.6)
FPL6	3/8" NPT	0.375" (9.5)	15,000 PSI 1030 bar	1.50" (38.1)	1.50" (38.1)	1.00" (25.4)	1.00" (25.4)	1.00" (25.4)	0.25" (6.4)	0.25" (6.4)	0.22" (5.6)
FPL8	1/2" NPT	0.500" (12.7)	15,000 PSI 1030 bar	1.75" (44.5)	1.75" (44.5)	1.25" (31.8)	1.25" (31.8)	1.25" (31.8)	0.37" (9.4)	0.37" (9.4)	0.28" (7.1)
FPL12	3/4" NPT	0.922" (23.4)	10,000 PSI 690 bar	2.62" (66.5)	2.12" (53.8)	1.31" (33.3)	1.38" (35.1)	1.50" (38.1)	N/A	N/A	N/A
FPL16	1" NPT	0.687" (17.4)	10,000 PSI 690 bar	3.00" (76.2)	2.56" (65.0)	1.69" (42.9)	1.69" (42.9)	1.75" (44.5)	0.50" (12.7)	0.50" (12.7)	0.22" (5.6)

\*Mounting hole provided when the catalog number is suffixed by "-MH" when ordering.

## STREET ELBOW

Catalog Number	Connection	Port	MAWP	A	B	C	D	Block Thickness
MSPL2	1/8" NPT	0.187" (4.7)	15,000 PSI 1030 bar	1.12" (28.4)	1.00" (25.4)	0.81" (20.6)	0.75" (19.1)	0.62" (15.7)
MSPL4	1/4" NPT	0.250" (6.4)	15,000 PSI 1030 bar	1.50" (38.1)	1.50" (38.1)	1.13" (28.7)	1.00" (25.4)	1.00" (25.4)
MSPL6	3/8" NPT	0.375" (9.5)	15,000 PSI 1030 bar	1.75" (44.5)	1.50" (38.1)	1.25" (31.8)	1.00" (25.4)	1.00" (25.4)
MSPL8	1/2" NPT	0.500" (12.7)	15,000 PSI 1030 bar	2.25" (57.2)	2.00" (50.8)	1.63" (41.4)	1.25" (31.8)	1.25" (31.8)
MSPL12	3/4" NPT	0.625" (15.9)	10,000 PSI 690 bar	2.50" (63.5)	2.62" (66.5)	1.75" (44.5)	1.31" (33.3)	1.50" (38.1)
MSPL16	1" NPT	0.687" (17.4)	10,000 PSI 690 bar	3.00" (76.2)	2.88" (73.2)	2.12" (53.8)	1.68" (42.7)	1.75" (44.5)

## MALE ELBOW

Catalog Number	Connection	Port	MAWP	A	B	C	D	Block Thickness
MPL2	1/8" NPT	0.187" (4.7)	15,000 PSI 1030 bar	1.00" (25.4)	1.13" (28.7)	0.75" (19.1)	0.81" (20.6)	0.62" (15.7)
MPL4	1/4" NPT	0.250" (6.4)	15,000 PSI 1030 bar	1.50" (38.1)	1.50" (38.1)	1.13" (28.7)	1.13" (28.7)	0.75" (19.1)
MPL6	3/8" NPT	0.375" (9.5)	15,000 PSI 1030 bar	1.75" (44.5)	1.75" (44.5)	1.25" (31.8)	1.25" (31.8)	1.00" (25.4)
MPL8	1/2" NPT	0.500" (12.7)	15,000 PSI 1030 bar	2.00" (50.8)	2.00" (50.8)	1.50" (38.1)	1.50" (38.1)	1.00" (25.4)
MPL12	3/4" NPT	0.625" (15.9)	10,000 PSI 690 bar	2.62" (66.5)	2.62" (66.5)	1.75" (44.5)	1.75" (44.5)	1.50" (38.1)
MPL16	1" NPT	0.687" (17.4)	10,000 PSI 690 bar	3.00" (76.2)	3.00" (76.2)	2.13" (54.1)	2.13" (54.1)	1.75" (44.5)

All dimensions are for reference only and are subject to change.  
Dimensions in parentheses are millimeters (mm)

# PIPE TEES

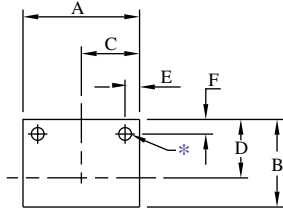

Female Tee

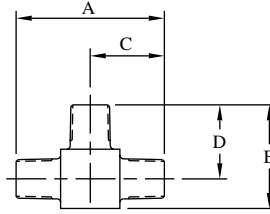

Male Tee

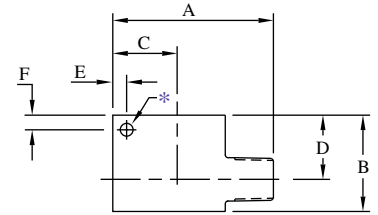

Male Street Tee

## FEMALE TEES

Catalog Number	Connection	Port	MAWP	A	B	C	D	Block Thickness	Mounting Holes*		
									E	F	Dia.
FPT2	1/8" NPT	0.187" (4.7)	15,000 PSI 1030 bar	1.50" (38.1)	1.00" (25.4)	0.75" (19.1)	0.62" (15.7)	0.62" (15.7)	0.25" (6.4)	0.20" (5.1)	0.22" (5.6)
FPT4	1/4" NPT	0.437" (11.1)	15,000 PSI 1030 bar	2.00" (50.8)	1.25" (31.8)	1.00" (25.4)	0.81" (20.6)	0.75" (19.1)	0.38" (9.7)	0.25" (6.4)	0.22" (5.6)
FPT6	3/8" NPT	0.375" (9.5)	15,000 PSI 1030 bar	2.00" (50.8)	1.50" (38.1)	1.00" (25.4)	1.00" (25.4)	1.00" (25.4)	0.25" (6.4)	0.25" (6.4)	0.22" (5.6)
FPT8	1/2" NPT	0.500" (12.7)	15,000 PSI 1030 bar	2.50" (63.5)	1.75" (44.5)	1.25" (31.8)	1.25" (31.8)	1.25" (31.8)	0.38" (9.7)	0.38" (9.7)	0.28" (7.1)
FPT12	3/4" NPT	0.922" (23.4)	10,000 PSI 690 bar	2.62" (66.5)	2.12" (53.8)	1.31" (33.3)	1.38" (35.1)	1.50" (38.1)	N/A	N/A	N/A
FPT16	1" NPT	0.687" (17.4)	10,000 PSI 690 bar	3.38" (85.9)	2.56" (65.0)	1.69" (42.9)	1.69" (42.9)	1.75" (44.5)	0.50" (12.7)	0.50" (12.7)	0.22" (5.6)

## MALE TEES

Catalog Number	Connection	Port	MAWP	A	B	C	D	Block Thickness	Mounting Holes*		
									E	F	Dia.
MPT2	1/8" NPT	0.187" (4.7)	15,000 PSI 1030 bar	1.50" (38.1)	1.13" (28.7)	0.75" (19.1)	0.81" (20.6)	0.62" (15.7)	N/A	N/A	N/A
MPT4	1/4" NPT	0.250" (6.4)	15,000 PSI 1030 bar	2.25" (57.2)	1.50" (38.1)	1.13" (28.7)	1.13" (28.7)	0.75" (19.1)	0.25" (6.4)	0.37" (9.4)	0.22" (5.6)
MPT6	3/8" NPT	0.375" (9.5)	15,000 PSI 1030 bar	2.50" (63.5)	1.75" (44.5)	1.25" (31.8)	1.25" (31.8)	1.00" (25.4)	N/A	N/A	N/A
MPT8	1/2" NPT	0.500" (12.7)	15,000 PSI 1030 bar	3.00" (76.2)	2.00" (50.8)	1.50" (38.1)	1.50" (38.1)	1.00" (25.4)	0.37" (9.4)	0.37" (9.4)	0.34" (8.6)
MPT12	3/4" NPT	0.625" (15.9)	10,000 PSI 690 bar	3.50" (88.9)	2.62" (66.5)	1.75" (44.5)	1.75" (44.5)	1.50" (38.1)	0.37" (9.4)	0.37" (9.4)	0.34" (8.6)
MPT16	1" NPT	0.687" (17.4)	10,000 PSI 690 bar	4.25" (108.0)	3.00" (76.2)	2.13" (54.1)	2.13" (54.1)	1.75" (44.5)	0.50" (12.7)	0.50" (12.7)	0.34" (8.6)

## MALE STREET TEES

Catalog Number	Connection	Port	MAWP	A	B	C	D	Block Thickness	Mounting Holes*		
									E	F	Dia.
MSPT2	1/8" NPT	0.187" (4.7)	15,000 PSI 1030 bar	1.50" (38.1)	1.12" (28.4)	0.63" (16.0)	0.75" (19.1)	0.62" (15.7)	N/A	N/A	N/A
MSPT4	1/4" NPT	0.250" (6.4)	15,000 PSI 1030 bar	2.00" (50.8)	1.37" (34.8)	0.81" (20.6)	1.00" (25.4)	0.75" (19.1)	0.25" (6.4)	0.37" (9.4)	0.22" (5.6)
MSPT6	3/8" NPT	0.375" (9.5)	15,000 PSI 1030 bar	2.50" (63.5)	1.50" (38.1)	1.00" (25.4)	1.00" (25.4)	1.00" (25.4)	N/A	N/A	N/A
MSPT8	1/2" NPT	0.500" (12.7)	15,000 PSI 1030 bar	2.75" (69.9)	1.75" (44.5)	1.25" (31.8)	1.25" (31.8)	1.25" (31.8)	0.37" (9.4)	0.37" (9.4)	0.34" (8.6)
MSPT12	3/4" NPT	0.625" (15.9)	10,000 PSI 690 bar	3.12" (79.2)	2.62" (66.5)	1.38" (35.1)	1.31" (33.3)	1.50" (38.1)	0.37" (9.4)	0.37" (9.4)	0.34" (8.6)
MSPT16	1" NPT	0.687" (17.4)	10,000 PSI 690 bar	4.25" (108.0)	3.00" (76.2)	2.13" (54.1)	2.13" (54.1)	1.75" (44.5)	0.50" (12.7)	0.50" (12.7)	0.34" (8.6)

\*Mounting holes provided when the catalog number is suffixed by "-MH" when ordering.

All dimensions are for reference only and are subject to change.  
Dimensions in parentheses are millimeters (mm)

# PIPE TEES, CROSSES AND BULKHEADS

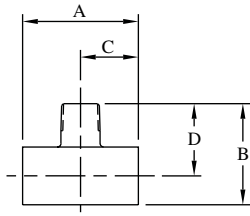

Male Branch Tee

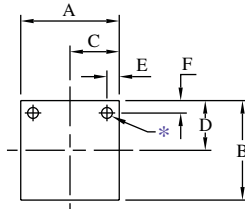

Female Cross

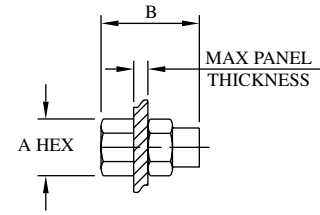

See bulkhead table below for panel hole drill size

## MALE BRANCH TEES

Catalog Number	Connection	Port	MAWP	A	B	C	D	Block Thickness
MBPT2	1/8" NPT	0.187" (4.7)	15,000 PSI 1030 bar	1.50" (38.1)	1.13" (28.7)	0.75" (19.1)	0.81" (20.6)	0.62" (15.7)
MBPT4	1/4" NPT	0.250" (6.4)	15,000 PSI 1030 bar	2.00" (50.8)	1.50" (38.1)	1.00" (25.4)	1.13" (28.7)	1.00" (25.4)
MBPT6	3/8" NPT	0.375" (9.5)	15,000 PSI 1030 bar	2.00" (50.8)	1.75" (44.5)	1.00" (25.4)	1.25" (31.8)	1.00" (25.4)
MBPT8	1/2" NPT	0.500" (12.7)	15,000 PSI 1030 bar	2.50" (63.5)	2.25" (57.2)	1.25" (31.8)	1.63" (41.4)	1.25" (31.8)
MBPT12	3/4" NPT	0.625" (15.9)	10,000 PSI 690 bar	2.62" (66.5)	2.50" (63.5)	1.31" (33.3)	1.75" (44.5)	1.50" (38.1)
MBPT16	1" NPT	0.687" (17.4)	10,000 PSI 690 bar	3.37" (85.6)	3.00" (76.2)	1.69" (42.9)	2.13" (54.1)	1.75" (44.5)

## FEMALE CROSSES

Catalog Number	Connection	Port	MAWP	A	B	C	D	Block Thickness	Mounting Holes*		
									E	F	Dia.
FPX2	1/8" NPT	0.187" (4.7)	15,000 PSI 1030 bar	1.50" (38.1)	1.50" (38.1)	0.75" (19.1)	0.75" (19.1)	0.62" (15.7)	0.25" (6.4)	0.25" (6.4)	0.22" (5.6)
FPX4	1/4" NPT	0.250" (6.4)	15,000 PSI 1030 bar	2.00" (50.8)	2.00" (50.8)	1.00" (25.4)	1.00" (25.4)	0.75" (19.1)	0.38" (9.7)	0.25" (6.4)	0.22" (5.6)
FPX6	3/8" NPT	0.375" (9.5)	15,000 PSI 1030 bar	2.00" (50.8)	2.00" (50.8)	1.00" (25.4)	1.00" (25.4)	1.00" (25.4)	0.25" (6.4)	0.25" (6.4)	0.22" (5.6)
FPX8	1/2" NPT	0.500" (12.7)	15,000 PSI 1030 bar	2.50" (63.5)	2.50" (63.5)	1.25" (31.8)	1.25" (31.8)	1.25" (31.8)	0.38" (9.7)	0.38" (9.7)	0.28" (7.1)
FPX12	3/4" NPT	0.922" (23.4)	10,000 PSI 690 bar	2.62" (66.5)	2.75" (69.9)	1.31" (33.3)	1.38" (35.1)	1.50" (38.1)	N/A	N/A	N/A
FPX16	1" NPT	0.687" (17.4)	10,000 PSI 690 bar	4.12" (104.6)	4.12" (104.6)	2.06" (52.3)	2.06" (52.3)	1.75" (44.5)	N/A	N/A	N/A

\*Mounting holes provided when the catalog number is suffixed by "-MH" when ordering.

## BULKHEADS

Catalog Number	Connection	Port	MAWP	A	B	Panel Hole	Panel Thickness
FPBF2	1/8" NPT	0.339" (8.6)	15,000 PSI 1030 bar	1.00" (25.4)	2.00" (50.8)	0.81" (20.6)	0.38" (9.7)
FPBF4	1/4" NPT	0.437" (11.1)	15,000 PSI 1030 bar	1.00" (25.4)	2.00" (50.8)	0.94" (23.9)	0.38" (9.7)
FPBF6	3/8" NPT	0.578" (14.7)	15,000 PSI 1030 bar	1.37" (34.8)	2.62" (66.5)	1.25" (31.8)	0.50" (12.7)
FPBF8	1/2" NPT	0.703" (17.9)	15,000 PSI 1030 bar	1.50" (38.1)	2.62" (66.5)	1.37" (34.8)	0.50" (12.7)
FPBF12	3/4" NPT	0.625" (15.9)	10,000 PSI 690 bar	1.88" (47.8)	2.62" (66.5)	1.69" (42.9)	0.50" (12.7)
FPBF16	1" NPT	0.687" (17.4)	10,000 PSI 690 bar	2.12" (53.8)	3.50" (88.9)	1.94" (49.3)	0.50" (12.7)

All dimensions are for reference only and are subject to change.  
Dimensions in parentheses are millimeters (mm)

# PIPE ADAPTERS

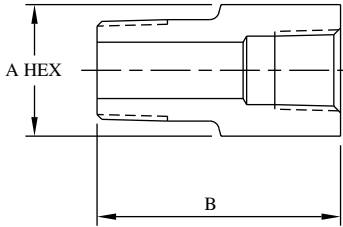

Catalog Number	Male NPT	Female NPT	Port	MAWP	A	B
10A2P4P	1/8"	1/4"	0.187" (4.7)	15,000 PSI 1030 bar	0.75" (19.1)	1.38" (35.1)
10A2P6P	1/8"	3/8"	0.187" (4.7)	15,000 PSI 1030 bar	1.00" (25.4)	1.56" (39.6)
10A2P8P	1/8"	1/2"	0.187" (4.7)	15,000 PSI 1030 bar	1.38" (35.1)	1.56" (39.6)
10A2P12P	1/8"	3/4"	0.187" (4.7)	10,000 PSI 690 bar	1.38" (35.1)	2.12" (53.8)
10A2P16P	1/8"	1"	0.187" (4.7)	10,000 PSI 690 bar	1.75" (44.5)	2.25" (57.2)
10A4P2P	1/4"	1/8"	0.187" (4.7)	15,000 PSI 1030 bar	0.75" (19.1)	1.50" (38.1)
10A4P6P	1/4"	3/8"	0.250" (6.4)	15,000 PSI 1030 bar	0.88" (22.4)	1.75" (44.5)
10A4P8P	1/4"	1/2"	0.250" (6.4)	15,000 PSI 1030 bar	1.38" (35.1)	1.75" (44.5)
10A4P12P	1/4"	3/4"	0.250" (6.4)	10,000 PSI 690 bar	1.38" (35.1)	2.25" (57.2)
10A4P16P	1/4"	1"	0.250" (6.4)	10,000 PSI 690 bar	1.75" (44.5)	2.38" (60.5)
10A6P2P	3/8"	1/8"	0.339" (8.6)	15,000 PSI 1030 bar	0.88" (22.4)	1.50" (38.1)
10A6P4P	3/8"	1/4"	0.375" (9.5)	15,000 PSI 1030 bar	0.88" (22.4)	1.62" (41.1)
10A6P8P	3/8"	1/2"	0.375" (9.5)	15,000 PSI 1030 bar	1.38" (35.1)	2.00" (50.8)
10A6P12P	3/8"	3/4"	0.375" (9.5)	10,000 PSI 690 bar	1.38" (35.1)	2.00" (50.8)
10A6P16P	3/8"	1"	0.375" (9.5)	10,000 PSI 690 bar	1.75" (44.5)	2.56" (65.0)

Catalog Number	Male NPT	Female NPT	Port	MAWP	A	B
10A8P2P	1/2"	1/8"	0.339" (8.6)	15,000 PSI 1030 bar	1.00" (25.4)	1.75" (44.5)
10A8P4P	1/2"	1/4"	0.250" (6.4)	15,000 PSI 1030 bar	1.00" (25.4)	1.81" (46.0)
10A8P6P	1/2"	3/8"	0.500" (12.7)	15,000 PSI 1030 bar	1.00" (25.4)	2.00" (50.8)
10A8P12P	1/2"	3/4"	0.500" (12.7)	10,000 PSI 690 bar	1.38" (35.1)	2.50" (63.5)
10A8P16P	1/2"	1"	0.500" (12.7)	10,000 PSI 690 bar	1.75" (44.5)	2.56" (65.0)
10A12P2P	3/4"	1/8"	0.339" (8.6)	10,000 PSI 690 bar	1.13" (28.7)	1.51" (38.4)
10A12P4P	3/4"	1/4"	0.437" (11.1)	10,000 PSI 690 bar	1.13" (28.7)	1.51" (38.4)
10A12P6P	3/4"	3/8"	0.578" (14.7)	10,000 PSI 690 bar	1.13" (28.7)	2.00" (50.8)
10A12P8P	3/4"	1/2"	0.625" (15.9)	10,000 PSI 690 bar	1.38" (35.1)	2.00" (50.8)
10A12P16P	3/4"	1"	0.625" (15.9)	10,000 PSI 690 bar	1.75" (44.5)	2.56" (65.0)
10A16P2P	1"	1/8"	0.339" (8.6)	10,000 PSI 690 bar	1.38" (35.1)	2.00" (50.8)
10A16P4P	1"	1/4"	0.250" (6.4)	10,000 PSI 690 bar	1.38" (35.1)	1.88" (47.8)
10A16P6P	1"	3/8"	0.578" (14.7)	10,000 PSI 690 bar	1.38" (35.1)	2.25" (57.2)
10A16P8P	1"	1/2"	0.500" (12.7)	10,000 PSI 690 bar	1.38" (35.1)	2.37" (60.2)
10A16P12P	1"	3/4"	0.625" (15.9)	10,000 PSI 690 bar	1.38" (35.1)	2.75" (69.9)

All dimensions are for reference only and are subject to change.  
Dimensions in parentheses are millimeters (mm)

# PIPE COUPLINGS

## COUPLINGS

Catalog					
Number	Connection	Port	MAWP	A	B
FPF2	1/8" NPT	0.339" (8.6)	15,000 PSI 1030 bar	0.63" (16.0)	1.00" (25.4)
FPF4	1/4" NPT	0.437" (11.1)	15,000 PSI 1030 bar	0.75" (19.1)	1.25" (31.8)
FPF6	3/8" NPT	0.578" (14.7)	15,000 PSI 1030 bar	1.00" (25.4)	1.38" (35.1)
FPF8	1/2" NPT	0.703" (17.9)	15,000 PSI 1030 bar	1.38" (35.1)	1.50" (38.1)
FPF12	3/4" NPT	0.922" (23.4)	10,000 PSI 690 bar	1.38" (35.1)	1.75" (44.5)
FPF16	1" NPT	1.156" (29.4)	10,000 PSI 690 bar	1.75" (44.5)	2.18" (55.4)

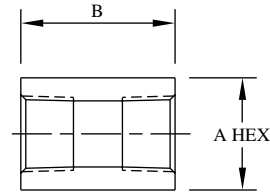

## REDUCER COUPLINGS

Catalog						
Number	End 1	End 2	Port	MAWP	A	B
10F2P4P	1/8" FNPT	1/4" FNPT	0.339" (8.6)	15,000 PSI 1030 bar	0.75" (19.1)	1.25" (31.8)
10F2P6P	1/8" FNPT	3/8" FNPT	0.339" (8.6)	15,000 PSI 1030 bar	1.00" (25.4)	1.38" (35.1)
10F2P8P	1/8" FNPT	1/2" FNPT	0.339" (8.6)	15,000 PSI 1030 bar	1.38" (31.8)	1.50" (38.1)
10F2P12P	1/8" FNPT	3/4" FNPT	0.339" (8.6)	10,000 PSI 690 bar	1.38" (35.1)	1.62" (41.1)
10F2P16P	1/8" FNPT	1" FNPT	0.339" (8.6)	10,000 PSI 690 bar	1.75" (44.5)	2.00" (50.8)
10F4P6P	1/4" FNPT	3/8" FNPT	0.437" (11.1)	15,000 PSI 1030 bar	1.00" (25.4)	1.38" (35.1)
10F4P8P	1/4" FNPT	1/2" FNPT	0.437" (11.1)	15,000 PSI 1030 bar	1.38" (35.1)	1.62" (41.1)
10F4P12P	1/4" FNPT	3/4" FNPT	0.374" (11.1)	10,000 PSI 690 bar	1.38" (35.1)	1.75" (44.5)
10F4P16P	1/4" FNPT	1" FNPT	0.437" (11.1)	10,000 PSI 690 bar	1.75" (44.5)	2.00" (50.8)
10F6P8P	3/8" FNPT	1/2" FNPT	0.578" (14.7)	15,000 PSI 1030 bar	1.38" (35.1)	1.63" (41.4)
10F6P12P	3/8" FNPT	3/4" FNPT	0.578" (14.7)	10,000 PSI 690 bar	1.38" (35.1)	1.75" (44.5)
10F6P16P	3/8" FNPT	1" FNPT	0.578" (14.7)	10,000 PSI 690 bar	1.75" (44.5)	2.00" (50.8)
10F8P12P	1/2" FNPT	3/4" FNPT	0.703" (17.9)	10,000 PSI 690 bar	1.38" (35.1)	1.75" (44.5)
10F8P16P	1/2" FNPT	1" FNPT	0.703" (17.9)	10,000 PSI 690 bar	1.75" (44.5)	2.19" (55.6)
10F12P16P	3/4" FNPT	1" FNPT	0.922" (23.4)	10,000 PSI 690 bar	1.75" (44.5)	2.18" (55.4)

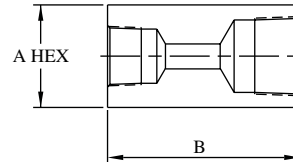

All dimensions are for reference only and are subject to change.  
Dimensions in parentheses are millimeters (mm)



# PIPE ACCESSORIES

## ZERO-CLEARANCE UNIONS

Catalog						
Number	Connection	Port	MAWP	A	B	C
FPUF2	1/8" NPT	0.339" (8.6)	15,000 PSI 1030 bar	1.50" (38.1)	2.38" (60.5)	0.62" (15.7)
FPUF4	1/4" NPT	0.437" (11.1)	15,000 PSI 1030 bar	1.75" (44.5)	2.56" (65.0)	0.75" (19.1)
FPUF6	3/8" NPT	0.578" (14.7)	15,000 PSI 1030 bar	1.87" (47.5)	2.83" (71.9)	0.87" (22.1)
FPUF8	1/2" NPT	0.703" (17.9)	15,000 PSI 1030 bar	1.87" (47.5)	2.83" (71.9)	1.00" (25.4)
FPUF12	3/4" NPT	0.921" (23.4)	10,000 PSI 690 bar	2.12" (53.8)	3.12" (79.2)	1.38" (35.1)

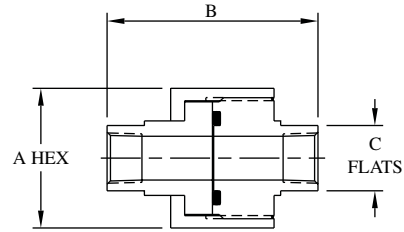

## PLUGS

Catalog				
Number	Connection	MAWP	A	B
MPP2	1/8" NPT	15,000 PSI 1030 bar	0.50" (12.7)	1.00" (25.4)
MPP4	1/4" NPT	15,000 PSI 1030 bar	0.63" (16.0)	1.12" (28.4)
MPP6	3/8" NPT	15,000 PSI 1030 bar	0.75" (19.1)	1.12" (28.4)
MPP8	1/2" NPT	15,000 PSI 1030 bar	1.00" (25.4)	1.50" (38.1)
MPP12	3/4" NPT	10,000 PSI 690 bar	1.38" (35.1)	1.50" (38.1)
MPP16	1" NPT	10,000 PSI 690 bar	1.38" (35.1)	1.88" (47.8)

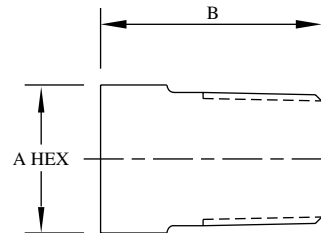

## CAPS

Catalog				
Number	Connection	MAWP	A	B
FPCA2	1/8" NPT	15,000 PSI 1030 bar	0.63" (16.0)	0.75" (19.1)
FPCA4	1/4" NPT	15,000 PSI 1030 bar	0.75" (19.1)	1.00" (25.4)
FPCA6	3/8" NPT	15,000 PSI 1030 bar	1.00" (25.4)	1.00" (25.4)
FPCA8	1/2" NPT	15,000 PSI 1030 bar	1.38" (35.1)	1.25" (31.8)
FPCA12	3/4" NPT	10,000 PSI 690 bar	1.38" (35.1)	1.50" (38.1)
FPCA16	1" NPT	10,000 PSI 690 bar	1.75" (44.5)	1.68" (42.7)

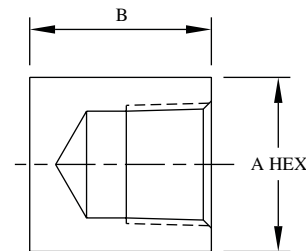

All dimensions are for reference only and are subject to change.  
Dimensions in parentheses are millimeters (mm)

# PIPE NIPPLES

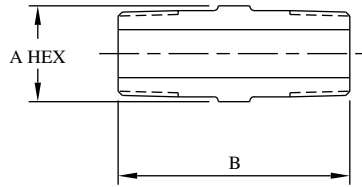

Catalog Number	End 1	End 2	Port	MAWP	A	B
MA2P2P	1/8" MNPT	1/8" MNPT	0.125" (3.2)	15,000 PSI 1030 bar	0.50" (12.7)	1.38" (35.1)
MA2P2P4	1/8" MNPT	1/8" MNPT	0.125" (3.2)	15,000 PSI 1030 bar	0.50" (12.7)	4.00" (101.6)
MA4P2P	1/4" MNPT	1/8" MNPT	0.187" (4.7)	15,000 PSI 1030 bar	0.63" (16.0)	1.62" (41.1)
MA4P4P	1/4" MNPT	1/4" MNPT	0.250" (6.4)	15,000 PSI 1030 bar	0.63" (16.0)	1.75" (44.5)
MA4P4P2	1/4" MNPT	1/4" MNPT	0.250" (6.4)	15,000 PSI 1030 bar	0.63" (16.0)	2.00" (50.8)
MA4P4P3	1/4" MNPT	1/4" MNPT	0.250" (6.4)	15,000 PSI 1030 bar	0.63" (16.0)	3.00" (76.2)
MA4P4P4	1/4" MNPT	1/4" MNPT	0.250" (6.4)	15,000 PSI 1030 bar	0.63" (16.0)	4.00" (101.6)
MA4P4P6	1/4" MNPT	1/4" MNPT	0.250" (6.4)	15,000 PSI 1030 bar	0.63" (16.0)	6.00" (152.4)
MA6P2P	3/8" MNPT	1/8" MNPT	0.187" (4.7)	15,000 PSI 1030 bar	0.75" (19.1)	1.62" (41.1)
MA6P4P	3/8" MNPT	1/4" MNPT	0.250" (6.4)	15,000 PSI 1030 bar	0.75" (19.1)	1.81" (46.0)
MA6P6P	3/8" MNPT	3/8" MNPT	0.375" (9.5)	15,000 PSI 1030 bar	0.75" (19.1)	1.81" (46.0)
MA6P6P3	3/8" MNPT	3/8" MNPT	0.375" (9.5)	15,000 PSI 1030 bar	0.75" (19.1)	3.00" (76.2)
MA8P2P	1/2" MNPT	1/8" MNPT	0.187" (4.7)	15,000 PSI 1030 bar	1.00" (25.4)	1.94" (49.3)
MA8P4P	1/2" MNPT	1/4" MNPT	0.250" (6.4)	15,000 PSI 1030 bar	1.00" (25.4)	2.12" (53.8)
MA8P6P	1/2" MNPT	3/8" MNPT	0.375" (9.5)	15,000 PSI 1030 bar	1.00" (25.4)	2.12" (53.8)
MA8P8P	1/2" MNPT	1/2" MNPT	0.500" (12.7)	15,000 PSI 1030 bar	1.00" (25.4)	2.50" (63.5)
MA8P8P4	1/2" MNPT	1/2" MNPT	0.500" (12.7)	15,000 PSI 1030 bar	1.00" (25.4)	4.00" (101.6)
MA8P8P6	1/2" MNPT	1/2" MNPT	0.500" (12.7)	15,000 PSI 1030 bar	1.00" (25.4)	6.00" (152.4)

Catalog Number	End 1	End 2	Port	MAWP	A	B
MA12P2P	3/4" MNPT	1/8" MNPT	0.187" (4.7)	10,000 PSI 690 bar	1.13" (28.7)	2.00" (50.8)
MA12P4P	3/4" MNPT	1/4" MNPT	0.250" (6.4)	10,000 PSI 690 bar	1.13" (28.7)	2.25" (57.2)
MA12P6P	3/4" MNPT	3/8" MNPT	0.375" (9.5)	10,000 PSI 690 bar	1.13" (28.7)	2.25" (57.2)
MA12P8P	3/4" MNPT	1/2" MNPT	0.500" (12.7)	10,000 PSI 690 bar	1.18" (30.0)	2.50" (63.5)
MA12P8P4	3/4" MNPT	1/2" MNPT	0.500" (12.7)	10,000 PSI 690 bar	1.18" (30.0)	4.00" (101.6)
MA12P12P2	3/4" MNPT	3/4" MNPT	0.625" (15.9)	10,000 PSI 690 bar	1.13" (28.7)	2.00" (50.8)
MA12P12P6	3/4" MNPT	3/4" MNPT	0.625" (15.9)	10,000 PSI 690 bar	1.13" (28.7)	6.00" (152.4)
MA16P2P	1" MNPT	1/8" MNPT	0.187" (4.7)	10,000 PSI 690 bar	1.38" (35.1)	2.25" (57.2)
MA16P4P	1" MNPT	1/4" MNPT	0.250" (6.4)	10,000 PSI 690 bar	1.38" (35.1)	2.50" (63.5)
MA16P6P	1" MNPT	3/8" MNPT	0.375" (9.5)	10,000 PSI 690 bar	1.38" (35.1)	2.50" (63.5)
MA16P8P	1" MNPT	1/2" MNPT	0.500" (12.7)	10,000 PSI 690 bar	1.38" (35.1)	2.75" (69.9)
MA16P12P	1" MNPT	3/4" MNPT	0.625" (15.9)	10,000 PSI 690 bar	1.38" (35.1)	2.75" (69.9)
MA16P16P	1" MNPT	1" MNPT	0.687" (17.4)	10,000 PSI 690 bar	1.38" (35.1)	3.00" (76.2)

All dimensions are for reference only and are subject to change.  
Dimensions in parentheses are millimeters (mm)

# PIPE CHECK VALVES

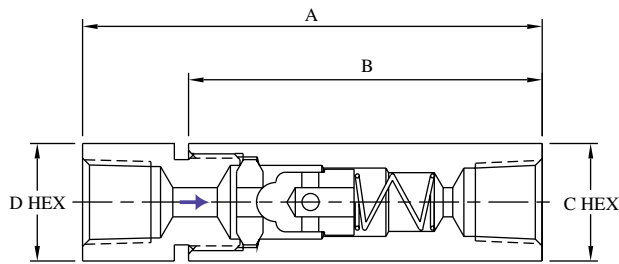

BuTech ball check valves prevent reverse flow where leak-tight shutoff is not necessary. Standard materials of construction are 316 stainless steel with 17-4PH poppet for longer life, and 300 series stainless steel spring.

Note: For 316 stainless steel wetted parts, add **-316WP** to the catalog number.

Cracking pressure: 15 PSI (1 bar) approximate

Operating Temperature Range:

-420° to +1200°F

(-251° to +648°C)

## BALL CHECK VALVES

Catalog Number	Connection	MAWP	Cv	A	B	C	D
FPBC2	1/8" NPT	15,000 PSI 1030 bar	0.15	2.62" (66.5)	2.12" (53.8)	0.63" (16.0)	0.50" (12.7)
FPBC4	1/4" NPT	15,000 PSI 1030 bar	0.63	2.94" (74.7)	2.26" (57.4)	0.75" (19.1)	0.75" (19.1)
FPBC6	3/8" NPT	15,000 PSI 1030 bar	0.80	3.54" (89.9)	2.62" (66.5)	1.12" (28.4)	1.00" (25.4)
FPBC8	1/2" NPT	15,000 PSI 1030 bar	2.30	4.32" (109.7)	3.50" (88.9)	1.38" (35.1)	1.38" (35.1)
FPBC12	3/4" NPT	10,000 PSI 690 bar	3.40	5.89" (149.6)	4.75" (120.7)	1.75" (44.5)	1.50" (38.1)
FPBC16	1" NPT	10,000 PSI 690 bar	5.20	7.29" (185.2)	5.75" (146.1)	2.12" (53.8)	1.75" (44.5)

To order a valve with a cracking pressure other than the standard 15 PSI, add the cracking pressure to the end of the catalog number. Example: An FPBC8 with 50 PSI cracking pressure would be ordered as **FPBC8-50**.

Cracking pressures available up to 100 PSI (7 bar)

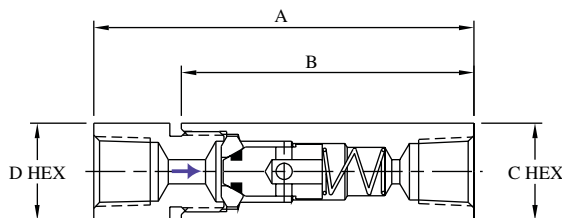

BuTech o-ring check valves reliably prevent backflow where leak-tight shutoff for liquids or gases is required. Standard materials of construction are 316 stainless steel with Buna-N o-ring and 300 series stainless steel spring.

Cracking pressure: 15 PSI (1 bar) approximate

Operating Temperature Ranges:

O-ring Material	Operating Temperature Range	Catalog Suffix
Buna-N	-65° to +250°F (-54° to +121°C)	----
Viton	-40° to +500°F (-40° to +260°C)	-VA
PTFE	-320° to +400°F (-195° to +204°C)	-TFE
Kalrez	-20° to +550°F (-29° to +288°C)	-HT

## O-RING CHECK VALVES

Catalog Number	Connection	MAWP	Cv	A	B	C	D
FPSC2	1/8" NPT	15,000 PSI 1030 bar	0.15	2.62" (66.5)	2.12" (53.8)	0.63" (16.0)	0.50" (12.7)
FPSC4	1/4" NPT	15,000 PSI 1030 bar	0.63	2.94" (74.7)	2.26" (57.4)	0.75" (19.1)	0.75" (19.1)
FPSC6	3/8" NPT	15,000 PSI 1030 bar	0.80	3.54" (89.9)	2.62" (66.5)	1.12" (28.4)	1.00" (25.4)
FPSC8	1/2" NPT	15,000 PSI 1030 bar	2.30	4.32" (109.7)	3.50" (88.9)	1.38" (35.1)	1.38" (35.1)
FPSC12	3/4" NPT	10,000 PSI 690 bar	3.40	5.89" (149.6)	4.75" (120.7)	1.75" (44.5)	1.50" (38.1)
FPSC16	1" NPT	10,000 PSI 690 bar	5.20	7.29" (185.2)	5.75" (146.1)	2.12" (53.8)	1.75" (44.5)

To order a valve with a cracking pressure other than the standard 15 PSI, add the cracking pressure to the end of the catalog number. Example: A FPSC4 with 40 PSI cracking pressure would be ordered as **FPSC4-40**.

Cracking pressures available up to 100 PSI (7 bar)

All dimensions are for reference only and are subject to change.  
Dimensions in parentheses are millimeters (mm)

# PIPE FILTERS

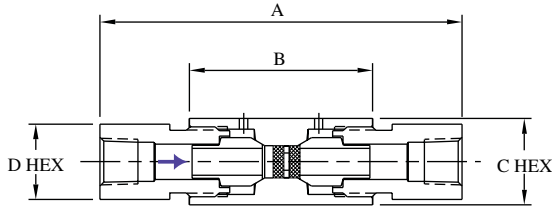

BuTech line filters are used in system lines to remove contaminating particles from the system fluid. Upstream filter of larger micron rating than downstream filter to prevent clogging of downstream filter.

Standard materials of construction are 316 stainless steel with 300 series stainless steel filter discs. Available in nominal ratings of: 0.5, 2, 5, 10, 20, 40, and 100 micron.

## LINE FILTERS

Catalog Number	Connection	MAWP	Area*	A	B	C	D
FPLF2	1/8" NPT	15,000 PSI 1030 bar	0.06 in <sup>2</sup> 39 mm <sup>2</sup>	3.62" (91.9)	1.75" (44.5)	0.75" (19.1)	0.63" (16.0)
FPLF4	1/4" NPT	15,000 PSI 1030 bar	0.15 in <sup>2</sup> 97 mm <sup>2</sup>	4.19" (106.4)	2.12" (53.8)	0.88" (22.4)	1.00" (25.4)
FPLF6	3/8" NPT	15,000 PSI 1030 bar	0.15 in <sup>2</sup> 97 mm <sup>2</sup>	5.20" (132.1)	2.12" (53.8)	1.00" (25.4)	1.00" (25.4)
FPLF8	1/2" NPT	15,000 PSI 1030 bar	0.30 in <sup>2</sup> 194 mm <sup>2</sup>	5.80" (147.3)	2.50" (63.5)	1.38" (35.1)	1.38" (35.1)
FPLF12	3/4" NPT	10,000 PSI 690 bar	0.50 in <sup>2</sup> 323 mm <sup>2</sup>	6.67" (169.4)	3.50" (88.9)	1.75" (44.5)	1.75" (44.5)
FPLF16	1" NPT	10,000 PSI 690 bar	0.50 in <sup>2</sup> 323 mm <sup>2</sup>	7.17" (182.1)	3.50" (88.9)	1.75" (44.5)	2.12" (53.8)

\*Effective area of filter element

Micron rating of filter must be specified. To order, complete the catalog number with the desired micron rating, upstream first:

### FPLF4-40/20

specifies a line filter with 1/4" NPT connections, a 40 micron filter upstream and 20 micron downstream.

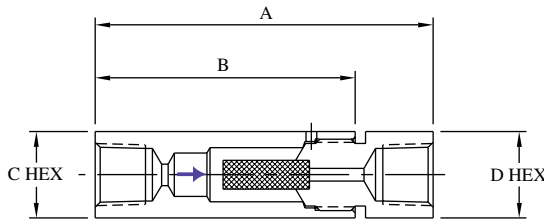

BuTech sintered cup filters offer maximum filtration surface area for removal of contaminating particles from the fluid system. They may be used in systems which require high flow rates with minimum pressure drop.

Standard materials of construction are 316 stainless steel with 300 series stainless steel filter discs. Available in nominal ratings of: 5, 10, 20, 40, and 100 micron.

## SINTERED CUP FILTERS

Catalog Number	Connection	MAWP	Area*	A	B	C	D
FPSCF2	1/8" NPT	15,000 PSI 1030 bar	0.54 in <sup>2</sup> 348 mm <sup>2</sup>	2.62" (66.5)	2.12" (53.8)	0.62" (15.7)	0.62" (15.7)
FPSCF4	1/4" NPT	15,000 PSI 1030 bar	0.54 in <sup>2</sup> 348 mm <sup>2</sup>	2.94" (74.7)	2.26" (57.4)	0.75" (19.1)	0.75" (19.1)
FPSCF6	3/8" NPT	15,000 PSI 1030 bar	1.47 in <sup>2</sup> 948 mm <sup>2</sup>	3.44" (87.4)	2.62" (66.5)	1.12" (28.4)	1.12" (28.4)
FPSCF8	1/2" NPT	15,000 PSI 1030 bar	1.47 in <sup>2</sup> 948 mm <sup>2</sup>	4.23" (107.4)	3.50" (88.9)	1.38" (35.1)	1.38" (35.1)
FPSCF12	3/4" NPT	10,000 PSI 690 bar	1.75 in <sup>2</sup> 1129 mm <sup>2</sup>	5.94" (150.9)	4.75" (120.7)	1.75" (44.5)	1.75" (44.5)
FPSCF16	1" NPT	10,000 PSI 690 bar	4.60 in <sup>2</sup> 2968 mm <sup>2</sup>	8.09" (205.5)	5.75" (146.1)	2.12" (53.8)	2.12" (53.8)

\*Effective area of filter element

Micron rating of filter must be specified. To order, complete the catalog number with the desired micron rating:

### FPSCF4-20

specifies a line filter with 1/4" NPT connections and a 20 micron filter.

# PIPE SAFETY HEADS & RUPTURE DISCS

BuTech safety head assemblies serve as holders for standard rupture discs (sold separately). Safety heads with rupture discs are used as simple and inexpensive overpressure relief devices. System pressure is relieved as a result of rupture of the replaceable disc.

The safety head assemblies shown are designed for use in high pressure systems up to 15,000 PSI (1030 bar). They can be installed directly into any of our standard couplings, elbows, tees, or crosses. Their versatility also allows direct installation into a standard 3-way valve. The result is a combination valve/safety head with beneficial cost and space advantages.

Standard material of construction is 316 stainless steel.

Safety head assemblies and rupture discs are available in two styles:

The **1/4A** style features a 1/4" blow-out diameter, an angular seat and can be ordered in pressures from 900 to 60,000 PSI (62 to 4140 bar)

The **1/2F** style features a 1/2" blow-out diameter, a flat seat and can be ordered in pressures from 500 to 10,000 PSI (34 to 689 bar). This style also has a reversible hold-down ring which greatly reduces the possibility of premature disc failure associated with installation errors inherent in some designs.

Rupture discs are available in a wide range of burst ratings. Factors such as corrosion, fatigue and temperature may affect the burst pressure of the disc and cause premature failure. This problem may sometimes be overcome by frequent replacement of the disc. All discs rated over 500 PSI (34 bar) have a manufacturing tolerance of 3% under to 6% over the specified rupture pressure rating.

Rupture Discs are not included in the safety head assembly. To order discs separately, use the following part numbering system:

<u>Style</u>	<u>Material</u>	<u>Pressure:</u>
4=1/4" Angled	AL=Aluminum	List desired pressure at 72°F
8=1/2" Flat	IN=Inconel	(21°C) in KSI.
	MO=Monel	
	NI=Nickel	
	SI=Silver	
	SS=316SS	
	TI=Titanium	

Examples:

An Inconel disc rated for 18,000 PSI in 1/4" Angled style would be ordered as **4IN18.00**

An Aluminum disc rated for 750 PSI in 1/2" Flat style would be ordered as **8AL0.750**

## SAFETY HEADS - 1/4" ANGLED DISC

Catalog Number	Connection	MAWP	A	B	C	Discharge
FPSH2-1/4A	1/8" NPT	15,000 PSI 1030 bar	1.00" (25.4)	2.62" (66.5)	1.00" (25.4)	3/8" FNPT
FPSH4-1/4A	1/4" NPT	15,000 PSI 1030 bar	1.00" (25.4)	2.87" (72.9)	1.00" (25.4)	3/8" FNPT
FPSH6-1/4A	3/8" NPT	15,000 PSI 1030 bar	1.00" (25.4)	2.87" (72.9)	1.00" (25.4)	3/8" FNPT
FPSH8-1/4A	1/2" NPT	15,000 PSI 1030 bar	1.00" (25.4)	2.68" (68.1)	1.00" (25.4)	3/8" FNPT

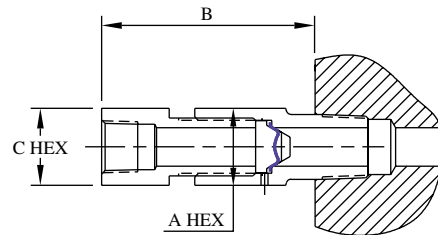

## SAFETY HEADS - 1/2" FLAT DISC

Catalog Number	Connection	MAWP	A	B	C	Discharge
FPSH2-1/2F	1/8" NPT	10,000 PSI 689 bar	1.00" (25.4)	2.62" (66.5)	1.00" (25.4)	3/8" FNPT
FPSH4-1/2F	1/4" NPT	10,000 PSI 689 bar	1.00" (25.4)	2.87" (72.9)	1.00" (25.4)	3/8" FNPT
FPSH6-1/2F	3/8" NPT	10,000 PSI 689 bar	1.00" (25.4)	2.87" (72.9)	1.00" (25.4)	3/8" FNPT
FPSH8-1/2F	1/2" NPT	10,000 PSI 689 bar	1.00" (25.4)	2.68" (68.1)	1.00" (25.4)	3/8" FNPT

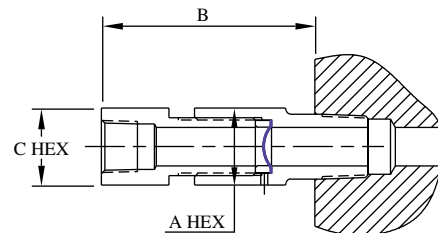

All dimensions are for reference only and are subject to change.  
Dimensions in parentheses are millimeters (mm)