

ADAPTERS, COUPLINGS AND ACCESSORIES

Series	Size	Connection	Size	Connection
Male/Female Adapters LPA 10A 20A 60A Female/Female Couplings LPC 10F 20F 60F Male/Male Adapters MA	1 = 1/16" 2 = 1/8" 4 = 1/4" 6 = 3/8" 8 = 1/2" 9 = 9/16" 12 = 3/4" 16 = 1"	L = LP P = NPT M = M/P H = H/P	1 = 1/16" 2 = 1/8" 4 = 1/4" 6 = 3/8" 8 = 1/2" 9 = 9/16" 12 = 3/4" 16 = 1"	L = LP P = NPT M = M/P H = H/P

Example:
10A4H8P specifies an adapter with 1/4" H/P Male on one end and 1/2" Female NPT on the other

BuTech offers a complete line of adapters and couplings manufactured from 316 cold-worked stainless steel. Pressure gauges, thermocouples and high-pressure hose are also available to complete your system.

In addition to the adapters and couplings shown on the following pages, BuTech also offers adapters with BSP, 37° Flare, SAE O-ring boss, Socket-Weld and Butt-Weld connections. Please contact the sales department.

To determine maximum allowable working pressure (MAWP) of an adapter or coupling:

Locate the rating of each connection in the chart below. The MAWP of the fitting will be the lesser of the two values.

	L/P	NPT	M/P	H/P
1/16"	15,000 PSI 1030 bar			
1/8"	15,000 PSI 1030 bar	15,000 PSI 1030 bar		
1/4"	11,500 PSI 790 bar	15,000 PSI 1030 bar	20,000 PSI 1380 bar	60,000 PSI 4140 bar
3/8"	7,500 PSI 520 bar	15,000 PSI 1030 bar	20,000 PSI 1380 bar	60,000 PSI 4140 bar
1/2"	5,500 PSI 380 bar	15,000 PSI 1030 bar		
9/16"			20,000 PSI 1380 bar	60,000 PSI 4140 bar
3/4"		10,000 PSI 690 bar	20,000 PSI 1380 bar	
1"		10,000 PSI 690 bar	20,000 PSI 1380 bar	

Equipment	Page
Male-Female Adapters	ACC-2
Male-Male Adapters	ACC-9
Couplings	ACC-11
Gauge Snubbers	ACC-15
Hose	ACC-14
Pressure Gauges	ACC-16
Thermocouples	ACC-15

Glands and collars or ferrules included with all female connections



All dimensions are for reference only and are subject to change.
 Dimensions in parentheses are millimeters (mm).



MALE-FEMALE ADAPTERS

Low Pressure Male x Low Pressure Female

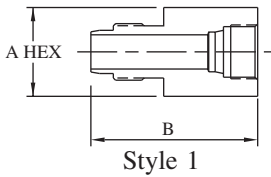

Style 1

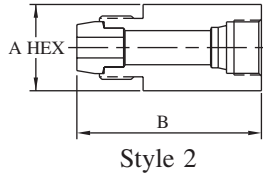

Style 2

Catalog Number	Male L/P	Female L/P	A		B		Port		Style
LPA2L2L	1/8"	1/8"	0.75"	(19.1)	1.50"	(38.1)	0.094"	(2.4)	1
LPA2L4L	1/8"	1/4"	0.75"	(19.1)	1.50"	(38.1)	0.094"	(2.4)	1
LPA2L6L	1/8"	3/8"	0.75"	(19.1)	1.50"	(38.1)	0.094"	(2.4)	1
LPA2L8L	1/8"	1/2"	0.75"	(19.1)	1.50"	(38.1)	0.094"	(2.4)	1
LPA4L2L	1/4"	1/8"	0.63"	(16.0)	1.52"	(38.6)	0.094"	(2.4)	2
LPA4L6L	1/4"	3/8"	0.75"	(19.1)	1.65"	(41.9)	0.187"	(4.7)	2
LPA4L8L	1/4"	1/2"	1.00"	(25.4)	1.87"	(47.5)	0.187"	(4.7)	2
LPA6L2L	3/8"	1/8"	0.75"	(19.1)	1.52"	(38.6)	0.094"	(2.4)	2
LPA6L4L	3/8"	1/4"	0.75"	(19.1)	1.77"	(45.0)	0.187"	(4.7)	2
LPA6L8L	3/8"	1/2"	0.75"	(19.1)	1.84"	(46.7)	0.187"	(4.7)	2
LPA8L2L	1/2"	1/8"	0.88"	(22.4)	1.84"	(46.7)	0.093"	(2.4)	2
LPA8L4L	1/2"	1/4"	0.88"	(22.4)	1.84"	(46.7)	0.187"	(4.7)	2
LPA8L6L	1/2"	3/8"	0.88"	(22.4)	1.84"	(46.7)	0.312"	(7.9)	2

Low Pressure Male x High Pressure Female

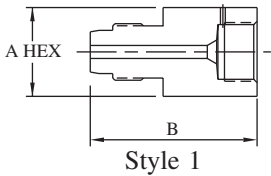

Style 1

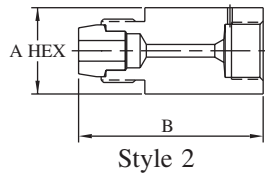

Style 2

Catalog Number	Male L/P	Female H/P	A		B		Port		Style
LPA2L4H	1/8"	1/4"	0.75"	(19.1)	1.50"	(38.1)	0.093"	(2.4)	1
LPA2L6H	1/8"	3/8"	1.00"	(25.4)	1.83"	(46.5)	0.093"	(2.4)	1
LPA2L9H	1/8"	9/16"	1.38"	(35.1)	1.87"	(47.5)	0.093"	(2.4)	1
LPA4L4H	1/4"	1/4"	0.75"	(19.1)	1.77"	(45.0)	0.093"	(2.4)	2
LPA4L6H	1/4"	3/8"	1.00"	(25.4)	1.75"	(44.5)	0.093"	(2.4)	2
LPA4L9H	1/4"	9/16"	1.38"	(35.1)	2.46"	(62.5)	0.187"	(4.7)	2
LPA6L4H	3/8"	1/4"	0.75"	(19.1)	1.65"	(41.9)	0.125"	(3.2)	2
LPA6L6H	3/8"	3/8"	1.00"	(25.4)	2.08"	(52.8)	0.125"	(3.2)	2
LPA6L9H	3/8"	9/16"	1.38"	(35.1)	2.09"	(53.1)	0.187"	(4.7)	2
LPA8L4H	1/2"	1/4"	1.38"	(35.1)	2.09"	(53.1)	0.093"	(2.4)	2
LPA8L6H	1/2"	3/8"	1.38"	(35.1)	2.09"	(53.1)	0.125"	(3.2)	2
LPA8L9H	1/2"	9/16"	1.38"	(35.1)	2.09"	(53.1)	0.250"	(6.4)	2

High Pressure Male x Low Pressure Female

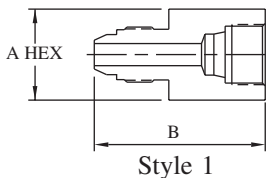

Style 1

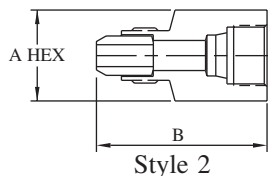

Style 2

Catalog Number	Male H/P	Female L/P	A		B		Port		Style
LPA4H2L	1/4"	1/8"	0.63"	(16.0)	1.43"	(36.3)	0.125"	(3.2)	2
LPA4H4L	1/4"	1/4"	0.75"	(19.1)	1.68"	(42.7)	0.082"	(2.1)	1
LPA4H6L	1/4"	3/8"	0.75"	(19.1)	1.68"	(42.7)	0.125"	(3.2)	2
LPA4H8L	1/4"	1/2"	0.75"	(19.1)	1.68"	(42.7)	0.125"	(3.2)	1
LPA6H2L	3/8"	1/8"	0.75"	(19.1)	1.62"	(41.1)	0.093"	(2.4)	1
LPA6H4L	3/8"	1/4"	0.75"	(19.1)	1.74"	(44.2)	0.125"	(3.2)	1
LPA6H6L	3/8"	3/8"	0.75"	(19.1)	2.00"	(50.8)	0.125"	(3.2)	1
LPA6H8L	3/8"	1/2"	0.75"	(19.1)	2.00"	(50.8)	0.218"	(5.5)	2
LPA9H2L	9/16"	1/8"	1.18"	(30.0)	2.06"	(52.3)	0.093"	(2.4)	2
LPA9H4L	9/16"	1/4"	1.18"	(30.0)	2.05"	(52.1)	0.187"	(4.7)	2
LPA9H6L	9/16"	3/8"	1.18"	(30.0)	2.06"	(52.3)	0.281"	(7.1)	2
LPA9H8L	9/16"	1/2"	1.13"	(28.7)	1.62"	(41.1)	0.281"	(7.1)	2

NOTE: See page ACC-1 to determine maximum allowable working pressure (MAWP)

All dimensions are for reference only and are subject to change.
Dimensions in parentheses are millimeters (mm).

MALE-FEMALE ADAPTERS

Low Pressure Male x Medium Pressure Female

Catalog Number	Male L/P	Female M/P	A		B		Port		Style
LPA2L4M	1/8"	1/4"	0.75"	(19.1)	1.50"	(38.1)	0.093"	(2.4)	1
LPA2L6M	1/8"	3/8"	0.75"	(19.1)	1.75"	(44.5)	0.093"	(2.4)	1
LPA2L9M	1/8"	9/16"	1.00"	(25.4)	2.00"	(50.8)	0.093"	(2.4)	1
LPA4L4M	1/4"	1/4"	0.75"	(19.1)	1.52"	(38.6)	0.125"	(3.2)	2
LPA4L6M	1/4"	3/8"	0.75"	(19.1)	1.77"	(45.0)	0.187"	(4.7)	2
LPA4L9M	1/4"	9/16"	1.00"	(25.4)	1.89"	(48.0)	0.187"	(4.7)	2
LPA4L12M	1/4"	3/4"	1.38"	(35.1)	2.27"	(57.7)	0.187"	(4.7)	2
LPA6L4M	3/8"	1/4"	0.75"	(19.1)	1.77"	(45.0)	0.109"	(2.8)	2
LPA6L6M	3/8"	3/8"	0.75"	(19.1)	2.02"	(51.3)	0.203"	(5.2)	2
LPA6L9M	3/8"	9/16"	1.00"	(25.4)	2.27"	(57.7)	0.312"	(7.9)	2
LPA6L12M	3/8"	3/4"	1.00"	(25.4)	2.31"	(58.7)	0.312"	(7.9)	2
LPA8L4M	1/2"	1/4"	0.88"	(22.4)	1.84"	(46.7)	0.109"	(2.8)	2
LPA8L6M	1/2"	3/8"	0.88"	(22.4)	2.09"	(53.1)	0.203"	(5.2)	2
LPA8L9M	1/2"	9/16"	1.00"	(25.4)	2.34"	(59.4)	0.359"	(9.1)	2
LPA8L12M	1/2"	3/4"	1.38"	(35.1)	2.34"	(59.4)	0.437"	(11.1)	2

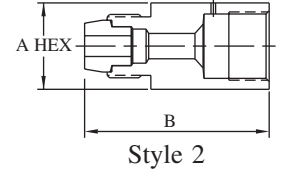
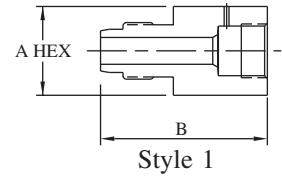

Medium Pressure Male x Low Pressure Female

Catalog Number	Male M/P	Female L/P	A		B		Port		Style
LPA4M2L	1/4"	1/8"	0.75"	(19.1)	1.50"	(38.1)	0.093"	(2.4)	1
LPA4M4L	1/4"	1/4"	0.75"	(19.1)	1.50"	(38.1)	0.109"	(2.8)	1
LPA4M6L	1/4"	3/8"	1.00"	(25.4)	1.65"	(41.9)	0.109"	(2.8)	1
LPA4M8L	1/4"	1/2"	1.00"	(25.4)	1.88"	(47.8)	0.109"	(2.8)	1
LPA6M2L	3/8"	1/8"	0.63"	(16.0)	1.25"	(31.8)	0.093"	(2.4)	2
LPA6M4L	3/8"	1/4"	0.75"	(19.1)	1.50"	(38.1)	0.187"	(4.7)	2
LPA6M6L	3/8"	3/8"	0.75"	(19.1)	1.50"	(38.1)	0.312"	(7.9)	2
LPA6M8L	3/8"	1/2"	0.75"	(19.1)	1.50"	(38.1)	0.250"	(6.4)	2
LPA9M2L	9/16"	1/8"	0.88"	(22.4)	1.50"	(38.1)	0.093"	(2.4)	2
LPA9M4L	9/16"	1/4"	0.88"	(22.4)	1.50"	(38.1)	0.187"	(4.7)	2
LPA9M6L	9/16"	3/8"	0.88"	(22.4)	1.50"	(38.1)	0.312"	(7.9)	2
LPA9M8L	9/16"	1/2"	1.00"	(25.4)	1.50"	(38.1)	0.312"	(7.9)	2
LPA12M2L	3/4"	1/8"	1.13"	(28.7)	2.00"	(50.8)	0.093"	(2.4)	2
LPA12M4L	3/4"	1/4"	1.13"	(28.7)	2.38"	(60.5)	0.187"	(4.7)	1
LPA12M6L	3/4"	3/8"	1.18"	(30.0)	1.62"	(41.1)	0.312"	(7.9)	3
LPA12M8L	3/4"	1/2"	1.38"	(35.1)	2.25"	(57.2)	0.437"	(11.1)	2
LPA16M2L	1"	1/8"	1.38"	(35.1)	2.19"	(55.6)	0.093"	(2.4)	3
LPA16M4L	1"	1/4"	1.38"	(35.1)	2.19"	(55.6)	0.187"	(4.7)	3
LPA16M6L	1"	3/8"	1.38"	(35.1)	2.25"	(57.2)	0.312"	(7.9)	2
LPA16M8L	1"	1/2"	1.38"	(35.1)	2.00"	(50.8)	0.312"	(7.9)	2

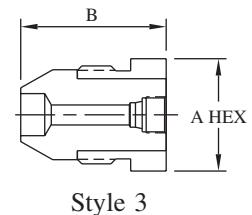
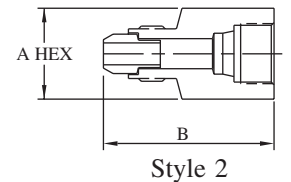
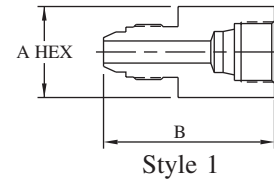

NOTE: See page ACC-1 to determine maximum allowable working pressure (MAWP)



All dimensions are for reference only and are subject to change.
Dimensions in parentheses are millimeters (mm).



MALE-FEMALE ADAPTERS

Low Pressure Male x NPT Female

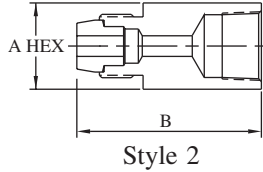
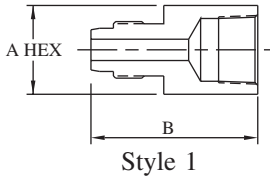

Catalog Number	Male L/P	Female NPT	A		B		Port		Style
LPA2L2P	1/8"	1/8"	0.75"	(19.1)	1.50"	(38.1)	0.093"	(2.4)	1
LPA2L4P	1/8"	1/4"	0.75"	(19.1)	1.50"	(38.1)	0.093"	(2.4)	1
LPA2L6P	1/8"	3/8"	0.75"	(19.1)	1.50"	(38.1)	0.093"	(2.4)	1
LPA2L8P	1/8"	1/2"	0.75"	(19.1)	1.50"	(38.1)	0.093"	(2.4)	1
LPA4L2P	1/4"	1/8"	0.63"	(16.0)	1.27"	(32.3)	0.187"	(4.7)	2
LPA4L4P	1/4"	1/4"	0.75"	(19.1)	1.52"	(38.6)	0.187"	(4.7)	2
LPA4L6P	1/4"	3/8"	1.00"	(25.4)	1.58"	(40.1)	0.187"	(4.7)	2
LPA4L8P	1/4"	1/2"	1.38"	(35.1)	1.89"	(48.0)	0.187"	(4.7)	2
LPA6L2P	3/8"	1/8"	0.75"	(19.1)	1.63"	(41.4)	0.125"	(3.2)	1
LPA6L4P	3/8"	1/4"	0.75"	(19.1)	1.65"	(41.9)	0.312"	(7.9)	2
LPA6L6P	3/8"	3/8"	0.75"	(19.1)	1.65"	(41.9)	0.312"	(7.9)	2
LPA6L8P	3/8"	1/2"	1.38"	(35.1)	1.89"	(48.0)	0.312"	(7.9)	2
LPA8L2P	1/2"	1/8"	1.00"	(25.4)	1.89"	(48.0)	0.437"	(11.1)	2
LPA8L4P	1/2"	1/4"	1.00"	(25.4)	1.81"	(46.0)	0.437"	(11.1)	1
LPA8L6P	1/2"	3/8"	1.00"	(25.4)	1.84"	(46.7)	0.437"	(11.1)	2
LPA8L8P	1/2"	1/2"	1.38"	(35.1)	2.09"	(53.1)	0.437"	(11.1)	2
LPA8L12P	1/2"	3/4"	1.75"	(44.5)	2.38"	(60.5)	0.437"	(11.1)	1

NPT Male x Low Pressure Female

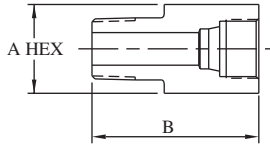

Catalog Number	Male NPT	Female L/P	A		B		Port	
LPA2P2L	1/8"	1/8"	0.50"	(12.7)	1.00"	(25.4)	0.093"	(2.4)
LPA2P4L	1/8"	1/4"	0.75"	(19.1)	1.50"	(38.1)	0.125"	(3.2)
LPA2P6L	1/8"	3/8"	0.75"	(19.1)	1.50"	(38.1)	0.125"	(3.2)
LPA2P8L	1/8"	1/2"	0.75"	(19.1)	1.50"	(38.1)	0.187"	(4.7)
LPA4P2L	1/4"	1/8"	0.75"	(19.1)	1.50"	(38.1)	0.093"	(2.4)
LPA4P4L	1/4"	1/4"	0.75"	(19.1)	1.50"	(38.1)	0.187"	(4.7)
LPA4P6L	1/4"	3/8"	0.75"	(19.1)	1.62"	(41.1)	0.187"	(4.7)
LPA4P8L	1/4"	1/2"	1.00"	(25.4)	2.00"	(50.8)	0.187"	(4.7)
LPA6P2L	3/8"	1/8"	0.75"	(19.1)	1.50"	(38.1)	0.093"	(2.4)
LPA6P4L	3/8"	1/4"	0.75"	(19.1)	1.62"	(41.1)	0.187"	(4.7)
LPA6P6L	3/8"	3/8"	0.75"	(19.1)	1.62"	(41.1)	0.250"	(6.4)
LPA6P8L	3/8"	1/2"	1.00"	(25.4)	2.00"	(50.8)	0.344"	(8.7)
LPA8P2L	1/2"	1/8"	1.00"	(25.4)	1.50"	(38.1)	0.093"	(2.4)
LPA8P4L	1/2"	1/4"	1.00"	(25.4)	1.75"	(44.5)	0.187"	(4.7)
LPA8P6L	1/2"	3/8"	1.00"	(25.4)	1.75"	(44.5)	0.312"	(7.9)
LPA8P8L	1/2"	1/2"	1.00"	(25.4)	2.00"	(50.8)	0.437"	(11.1)
LPA12P8L	3/4"	1/2"	1.38"	(35.1)	2.25"	(57.2)	0.437"	(11.1)
LPA16P6L	1"	3/8"	1.38"	(35.1)	2.00"	(50.8)	0.312"	(7.9)
LPA16P8L	1"	1/2"	1.38"	(35.1)	2.25"	(57.2)	0.312"	(7.9)

NOTE: See page ACC-1 to determine maximum allowable working pressure (MAWP)

All dimensions are for reference only and are subject to change.
Dimensions in parentheses are millimeters (mm).

MALE-FEMALE ADAPTERS

NPT Male x Medium Pressure Female

Catalog Number	Male NPT	Female M/P	A		B		Port
10A2P4M	1/8"	1/4"	0.75"	(19.1)	1.50"	(38.1)	0.109" (2.8)
10A2P6M	1/8"	3/8"	0.75"	(19.1)	1.75"	(44.5)	0.203" (5.2)
10A2P9M	1/8"	9/16"	1.00"	(25.4)	2.00"	(50.8)	0.218" (5.5)
10A4P4M	1/4"	1/4"	0.75"	(19.1)	1.50"	(38.1)	0.109" (2.8)
10A4P6M	1/4"	3/8"	0.75"	(19.1)	1.75"	(44.5)	0.203" (5.2)
10A4P9M	1/4"	9/16"	1.00"	(25.4)	2.00"	(50.8)	0.250" (6.4)
10A4P12M	1/4"	3/4"	1.38"	(35.1)	2.50"	(63.5)	0.250" (6.4)
10A6P4M	3/8"	1/4"	0.75"	(19.1)	1.50"	(38.1)	0.109" (2.8)
10A6P6M	3/8"	3/8"	0.75"	(19.1)	1.75"	(44.5)	0.203" (5.2)
10A6P9M	3/8"	9/16"	1.00"	(25.4)	2.00"	(50.8)	0.359" (9.1)
10A6P12M	3/8"	3/4"	1.38"	(35.1)	2.50"	(63.5)	0.375" (9.5)
10A8P4M	1/2"	1/4"	1.00"	(25.4)	1.50"	(38.1)	0.125" (3.2)
10A8P6M	1/2"	3/8"	1.00"	(25.4)	1.75"	(44.5)	0.203" (5.2)
10A8P9M	1/2"	9/16"	1.00"	(25.4)	2.00"	(50.8)	0.359" (9.1)
10A8P12M	1/2"	3/4"	1.38"	(35.1)	2.50"	(63.5)	0.516" (13.1)
10A8P16M	1/2"	1"	1.75"	(44.5)	3.00"	(76.2)	0.437" (11.1)
10A12P4M	3/4"	1/4"	1.38"	(35.1)	2.12"	(53.8)	0.187" (4.7)
10A12P6M	3/4"	3/8"	1.38"	(35.1)	2.25"	(57.2)	0.203" (5.2)
10A12P9M	3/4"	9/16"	1.38"	(35.1)	2.25"	(57.2)	0.359" (9.1)
10A12P12M	3/4"	3/4"	1.38"	(35.1)	2.50"	(63.5)	0.500" (12.7)
10A12P16M	3/4"	1"	1.75"	(44.5)	3.00"	(76.2)	0.500" (12.7)
10A16P9M	1"	9/16"	1.38"	(35.1)	2.25"	(57.2)	0.359" (9.1)
10A16P12M	1"	3/4"	1.38"	(35.1)	2.50"	(63.5)	0.359" (9.1)
10A16P16M	1"	1"	1.75"	(44.5)	3.00"	(76.2)	0.563" (14.3)

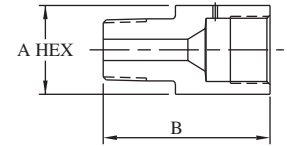

NPT Male x High Pressure Female

Catalog Number	Male NPT	Female H/P	A		B		Port
10A2P4H	1/8"	1/4"	0.75"	(19.1)	1.50"	(38.1)	0.093" (2.4)
10A2P6H	1/8"	3/8"	1.00"	(25.4)	1.75"	(44.5)	0.125" (3.2)
10A2P9H	1/8"	9/16"	1.38"	(35.1)	2.25"	(57.2)	0.187" (4.7)
10A4P4H	1/4"	1/4"	0.75"	(19.1)	1.50"	(38.1)	0.093" (2.4)
10A4P6H	1/4"	3/8"	1.00"	(25.4)	1.75"	(44.5)	0.125" (3.2)
10A4P9H	1/4"	9/16"	1.38"	(35.1)	2.25"	(57.2)	0.187" (4.7)
10A6P4H	3/8"	1/4"	0.75"	(19.1)	1.50"	(38.1)	0.093" (2.4)
10A6P6H	3/8"	3/8"	1.00"	(25.4)	1.75"	(44.5)	0.125" (3.2)
10A6P9H	3/8"	9/16"	1.38"	(35.1)	2.25"	(57.2)	0.187" (4.7)
10A8P4H	1/2"	1/4"	1.00"	(25.4)	1.62"	(41.1)	0.093" (2.4)
10A8P6H	1/2"	3/8"	1.00"	(25.4)	1.75"	(44.5)	0.125" (3.2)
10A8P9H	1/2"	9/16"	1.38"	(35.1)	2.25"	(57.2)	0.187" (4.7)
10A12P4H	3/4"	1/4"	1.13"	(28.7)	2.00"	(50.8)	0.093" (2.4)
10A12P6H	3/4"	3/8"	1.13"	(28.7)	2.00"	(50.8)	0.125" (3.2)
10A12P9H	3/4"	9/16"	1.38"	(35.1)	2.25"	(57.2)	0.187" (4.7)
10A16P4H	1"	1/4"	1.38"	(35.1)	1.75"	(44.5)	0.093" (2.4)
10A16P6H	1"	3/8"	1.38"	(35.1)	2.00"	(50.8)	0.125" (3.2)
10A16P9H	1"	9/16"	1.38"	(35.1)	2.25"	(57.2)	0.187" (4.7)

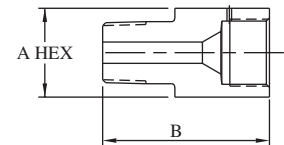

NOTE: See page ACC-1 to determine maximum allowable working pressure (MAWP)



All dimensions are for reference only and are subject to change.
Dimensions in parentheses are millimeters (mm).

MALE-FEMALE ADAPTERS

Medium Pressure Male x NPT Female

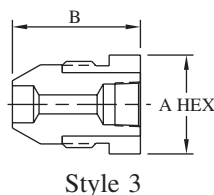
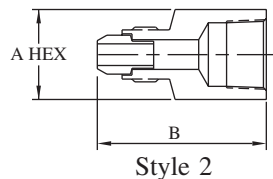
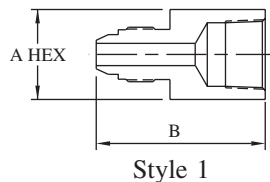

Catalog Number	Male M/P	Female NPT	A		B		Port		Style
10A4M2P	1/4"	1/8"	0.63"	(16.0)	1.56"	(39.6)	0.109"	(2.8)	1
10A4M4P	1/4"	1/4"	0.75"	(19.1)	1.63"	(41.4)	0.109"	(2.8)	1
10A4M6P	1/4"	3/8"	1.00"	(25.4)	2.00"	(50.8)	0.109"	(2.8)	1
10A4M8P	1/4"	1/2"	1.38"	(35.1)	2.19"	(55.6)	0.109"	(2.8)	1
10A6M2P	3/8"	1/8"	0.63"	(16.0)	1.62"	(41.1)	0.125"	(3.2)	2
10A6M4P	3/8"	1/4"	0.75"	(19.1)	1.88"	(47.8)	0.250"	(6.4)	2
10A6M6P	3/8"	3/8"	1.00"	(25.4)	1.88"	(47.8)	0.250"	(6.4)	2
10A6M8P	3/8"	1/2"	1.38"	(35.1)	2.13"	(54.1)	0.250"	(6.4)	2
10A9M2P	9/16"	1/8"	0.88"	(22.4)	1.88"	(47.8)	0.339"	(8.6)	2
10A9M4P	9/16"	1/4"	0.88"	(22.4)	1.88"	(47.8)	0.406"	(10.3)	2
10A9M6P	9/16"	3/8"	1.00"	(25.4)	2.38"	(60.5)	0.406"	(10.3)	2
10A9M8P	9/16"	1/2"	1.00"	(25.4)	2.38"	(60.5)	0.406"	(10.3)	2
10A9M12P	9/16"	3/4"	1.75"	(44.5)	2.62"	(66.5)	0.406"	(10.3)	2
10A9M16P	9/16"	1"	1.75"	(44.5)	2.62"	(66.5)	0.406"	(10.3)	2
10A12M2P	3/4"	1/8"	1.13"	(28.7)	2.40"	(61.0)	0.250"	(6.4)	2
10A12M4P	3/4"	1/4"	1.13"	(28.7)	2.40"	(61.0)	0.250"	(6.4)	2
10A12M6P	3/4"	3/8"	1.13"	(28.7)	2.62"	(66.5)	0.563"	(14.3)	2
10A12M8P	3/4"	1/2"	1.38"	(35.1)	2.62"	(66.5)	0.563"	(14.3)	2
10A12M12P	3/4"	3/4"	1.75"	(44.5)	2.90"	(73.7)	0.437"	(11.1)	2
10A12M16P	3/4"	1"	2.13"	(54.1)	2.62"	(66.5)	0.563"	(14.3)	2
10A16M2P	1"	1/8"	1.38"	(35.1)	2.62"	(66.5)	0.250"	(6.4)	2
10A16M4P	1"	1/4"	1.38"	(35.1)	2.62"	(66.5)	0.250"	(6.4)	1
10A16M6P	1"	3/8"	1.38"	(35.1)	2.19"	(55.6)	0.563"	(14.3)	3
10A16M8P	1"	1/2"	1.38"	(35.1)	2.80"	(71.1)	0.703"	(17.9)	2
10A16M12P	1"	3/4"	1.75"	(44.5)	2.80"	(71.1)	0.718"	(18.2)	2
10A16M16P	1"	1"	2.13"	(54.1)	3.30"	(83.8)	0.718"	(18.2)	2

High Pressure Male x NPT Female

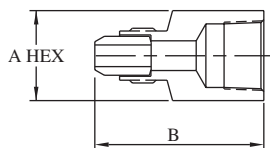

Catalog Number	Male H/P	Female NPT	A		B		Port	
10A4H2P	1/4"	1/8"	0.63"	(16.0)	1.43"	(36.3)	0.125"	(3.2)
10A4H4P	1/4"	1/4"	0.75"	(19.1)	1.68"	(42.7)	0.125"	(3.2)
10A4H6P	1/4"	3/8"	1.00"	(25.4)	1.68"	(42.7)	0.125"	(3.2)
10A4H8P	1/4"	1/2"	1.38"	(35.1)	1.93"	(49.0)	0.125"	(3.2)
10A6H2P	3/8"	1/8"	0.75"	(19.1)	1.75"	(44.5)	0.218"	(5.5)
10A6H4P	3/8"	1/4"	1.00"	(25.4)	2.00"	(50.8)	0.218"	(5.5)
10A6H6P	3/8"	3/8"	1.00"	(25.4)	2.00"	(50.8)	0.218"	(5.5)
10A6H8P	3/8"	1/2"	1.38"	(35.1)	2.38"	(60.5)	0.218"	(5.5)
10A9H2P	9/16"	1/8"	1.18"	(30.0)	2.06"	(52.3)	0.281"	(7.1)
10A9H4P	9/16"	1/4"	1.18"	(30.0)	2.06"	(52.3)	0.281"	(7.1)
10A9H6P	9/16"	3/8"	1.18"	(30.0)	2.06"	(52.3)	0.281"	(7.1)
10A9H8P	9/16"	1/2"	1.38"	(35.1)	2.06"	(52.3)	0.281"	(7.1)
10A9H12P	9/16"	3/4"	1.75"	(44.5)	2.69"	(68.3)	0.281"	(7.1)
10A9H16P	9/16"	1"	2.13"	(54.1)	2.93"	(74.4)	0.281"	(7.1)

NOTE: See page ACC-1 to determine maximum allowable working pressure (MAWP)

All dimensions are for reference only and are subject to change.
Dimensions in parentheses are millimeters (mm).

MALE-FEMALE ADAPTERS

Medium Pressure Male x Medium Pressure Female

Catalog Number	Male M/P	Female M/P	A		B		Port	Style	
20A4M6M	1/4"	3/8"	0.75"	(19.1)	1.75"	(44.5)	0.109"	(2.8)	1
20A4M9M	1/4"	9/16"	1.00"	(25.4)	2.00"	(50.8)	0.109"	(2.8)	1
20A4M12M	1/4"	3/4"	1.38"	(35.1)	2.50"	(63.5)	0.109"	(2.8)	1
20A4M16M	1/4"	1"	1.75"	(44.5)	3.00"	(76.2)	0.109"	(2.8)	1
20A6M4M	3/8"	1/4"	0.75"	(19.1)	1.88"	(47.8)	0.109"	(2.8)	2
20A6M9M	3/8"	9/16"	1.00"	(25.4)	2.38"	(60.5)	0.250"	(6.4)	2
20A6M12M	3/8"	3/4"	1.38"	(35.1)	2.55"	(64.8)	0.125"	(3.2)	2
20A6M16M	3/8"	1"	1.75"	(44.5)	3.13"	(79.5)	0.250"	(6.4)	2
20A9M4M	9/16"	1/4"	0.88"	(22.4)	1.88"	(47.8)	0.109"	(2.8)	2
20A9M6M	9/16"	3/8"	0.88"	(22.4)	1.88"	(47.8)	0.203"	(5.2)	2
20A9M12M	9/16"	3/4"	1.38"	(35.1)	2.88"	(73.2)	0.312"	(7.9)	2
20A9M16M	9/16"	1"	1.75"	(44.5)	3.38"	(85.9)	0.312"	(7.9)	2
20A12M4M	3/4"	1/4"	1.18"	(30.0)	1.62"	(41.1)	0.125"	(3.2)	3
20A12M6M	3/4"	3/8"	1.18"	(30.0)	1.62"	(41.1)	0.203"	(5.2)	3
20A12M9M	3/4"	9/16"	1.13"	(28.7)	1.69"	(42.9)	0.359"	(9.1)	4
20A12M12M	3/4"	3/4"	1.38"	(35.1)	2.65"	(67.3)	0.438"	(11.1)	2
20A12M16M	3/4"	1"	1.75"	(44.5)	3.40"	(86.4)	0.437"	(11.1)	2
20A16M4M	1"	1/4"	1.38"	(35.1)	2.19"	(55.6)	0.125"	(3.2)	3
20A16M6M	1"	3/8"	1.38"	(35.1)	2.19"	(55.6)	0.203"	(5.2)	3
20A16M9M	1"	9/16"	1.38"	(35.1)	2.19"	(55.6)	0.359"	(9.1)	3
20A16M12M	1"	3/4"	1.38"	(35.1)	3.05"	(77.5)	0.516"	(13.1)	2
20A16M16M	1"	1"	1.75"	(44.5)	3.55"	(90.2)	0.563"	(14.3)	2

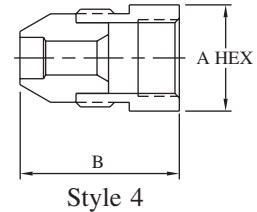
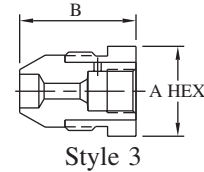
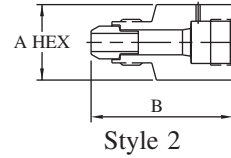
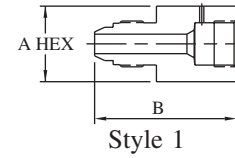

Medium Pressure Male x High Pressure Female

Catalog Number	Male M/P	Female H/P	A		B		Port	Style	
20A4M4H	1/4"	1/4"	0.75"	(19.1)	1.50"	(38.1)	0.109"	(2.8)	1
20A4M6H	1/4"	3/8"	1.00"	(25.4)	1.75"	(44.5)	0.125"	(3.2)	1
20A4M9H	1/4"	9/16"	1.00"	(25.4)	1.75"	(44.5)	0.140"	(3.6)	1
20A6M4H	3/8"	1/4"	0.75"	(19.1)	1.88"	(47.8)	0.093"	(2.4)	2
20A6M6H	3/8"	3/8"	1.00"	(25.4)	2.13"	(54.1)	0.125"	(3.2)	2
20A6M9H	3/8"	9/16"	1.38"	(35.1)	2.50"	(63.5)	0.188"	(4.8)	2
20A9M4H	9/16"	1/4"	0.88"	(22.4)	1.88"	(47.8)	0.188"	(4.8)	2
20A9M6H	9/16"	3/8"	1.00"	(25.4)	2.13"	(54.1)	0.125"	(3.2)	2
20A9M9H	9/16"	9/16"	1.38"	(35.1)	2.63"	(66.8)	0.187"	(4.7)	2
20A12M4H	3/4"	1/4"	1.18"	(30.0)	1.62"	(41.1)	0.093"	(2.4)	3
20A12M6H	3/4"	3/8"	1.13"	(28.7)	2.40"	(61.0)	0.125"	(3.2)	2
20A12M9H	3/4"	9/16"	1.38"	(35.1)	2.65"	(67.3)	0.187"	(4.7)	2
20A16M4H	1"	1/4"	1.38"	(35.1)	2.19"	(55.6)	0.093"	(2.4)	3
20A16M6H	1"	3/8"	1.38"	(35.1)	2.19"	(55.6)	0.125"	(3.2)	2
20A16M9H	1"	9/16"	1.38"	(35.1)	2.80"	(71.1)	0.188"	(4.8)	2

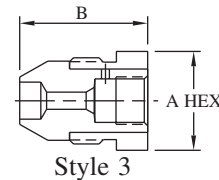
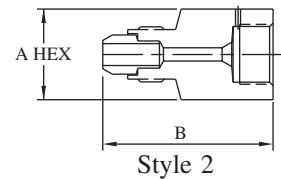
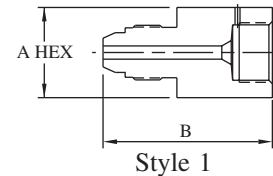

NOTE: See page ACC-1 to determine maximum allowable working pressure (MAWP)



All dimensions are for reference only and are subject to change.
Dimensions in parentheses are millimeters (mm).

Page ACC-7



MALE-FEMALE ADAPTERS

High Pressure Male x Medium Pressure Female

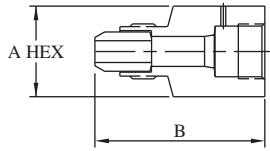

Catalog Number	Male H/P	Female M/P	A		B		Port	
20A4H4M	1/4"	1/4"	0.75"	(19.1)	1.68"	(42.7)	0.109"	(2.8)
20A4H6M	1/4"	3/8"	0.75"	(19.1)	1.93"	(49.0)	0.125"	(3.2)
20A4H9M	1/4"	9/16"	1.00"	(25.4)	2.18"	(55.4)	0.125"	(3.2)
20A4H12M	1/4"	3/4"	1.38"	(35.1)	2.68"	(68.1)	0.125"	(3.2)
20A4H16M	1/4"	1"	1.75"	(44.5)	2.75"	(69.9)	0.125"	(3.2)
20A6H4M	3/8"	1/4"	0.75"	(19.1)	1.75"	(44.5)	0.109"	(2.8)
20A6H6M	3/8"	3/8"	0.75"	(19.1)	2.00"	(50.8)	0.203"	(5.2)
20A6H9M	3/8"	9/16"	1.00"	(25.4)	2.25"	(57.2)	0.218"	(5.5)
20A6H12M	3/8"	3/4"	1.38"	(35.1)	2.75"	(69.9)	0.218"	(5.5)
20A6H16M	3/8"	1"	1.75"	(44.5)	3.25"	(82.6)	0.218"	(5.5)
20A9H4M	9/16"	1/4"	1.18"	(30.0)	2.06"	(52.3)	0.125"	(3.2)
20A9H6M	9/16"	3/8"	1.18"	(30.0)	2.06"	(52.3)	0.203"	(5.2)
20A9H9M	9/16"	9/16"	1.18"	(30.0)	2.06"	(52.3)	0.281"	(7.1)
20A9H12M	9/16"	3/4"	1.37"	(34.8)	2.81"	(71.4)	0.281"	(7.1)
20A9H16M	9/16"	1"	1.75"	(44.5)	3.31"	(84.1)	0.281"	(7.1)

High Pressure Male x High Pressure Female

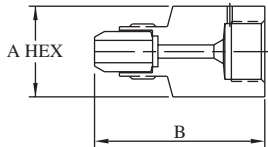

Catalog Number	Male H/P	Female H/P	A		B		Port	
60A4H4H	1/4"	1/4"	0.75"	(19.1)	1.43"	(36.3)	0.093"	(2.4)
60A4H6H	1/4"	3/8"	1.00"	(25.4)	1.93"	(49.0)	0.125"	(3.2)
60A4H9H	1/4"	9/16"	1.38"	(35.1)	2.43"	(61.7)	0.125"	(3.2)
60A6H4H	3/8"	1/4"	0.75"	(19.1)	1.75"	(44.5)	0.093"	(2.4)
60A6H9H	3/8"	9/16"	1.38"	(35.1)	2.00"	(50.8)	0.188"	(4.8)
60A9H4H	9/16"	1/4"	1.18"	(30.0)	1.75"	(44.5)	0.093"	(2.4)
60A9H6H	9/16"	3/8"	1.18"	(30.0)	1.87"	(47.5)	0.125"	(3.2)
60A9H9H	9/16"	9/16"	1.38"	(35.1)	2.56"	(65.0)	0.188"	(4.8)

NOTE: See page ACC-1 to determine maximum allowable working pressure (MAWP)

All dimensions are for reference only and are subject to change.
Dimensions in parentheses are millimeters (mm).

MALE-MALE ADAPTERS

Medium Pressure Male x NPT Male

Catalog Number	Male M/P	Male NPT	A		B		Port	Style	
MA4M2P	1/4"	1/8"	0.88"	(22.4)	2.25"	(57.2)	0.109"	(2.8)	1
MA4M4P	1/4"	1/4"	0.88"	(22.4)	2.25"	(57.2)	0.109"	(2.8)	1
MA4M6P	1/4"	3/8"	0.88"	(22.4)	2.25"	(57.2)	0.109"	(2.8)	1
MA4M8P	1/4"	1/2"	1.00"	(25.4)	2.50"	(63.5)	0.109"	(2.8)	1
MA4M12P	1/4"	3/4"	1.38"	(35.1)	2.38"	(60.5)	0.109"	(2.8)	1
MA6M2P	3/8"	1/8"	0.75"	(19.1)	2.12"	(53.8)	0.187"	(4.7)	2
MA6M4P	3/8"	1/4"	0.75"	(19.1)	2.37"	(60.2)	0.250"	(6.4)	2
MA6M6P	3/8"	3/8"	0.75"	(19.1)	2.37"	(60.2)	0.250"	(6.4)	2
MA6M8P	3/8"	1/2"	1.00"	(25.4)	2.50"	(63.5)	0.198"	(5.0)	1
MA6M12P	3/8"	3/4"	1.38"	(35.1)	2.37"	(60.2)	0.250"	(6.4)	2
MA9M2P	9/16"	1/8"	1.00"	(25.4)	2.50"	(63.5)	0.281"	(7.1)	2
MA9M4P	9/16"	1/4"	0.88"	(22.4)	2.63"	(66.8)	0.250"	(6.4)	2
MA9M6P	9/16"	3/8"	1.00"	(25.4)	2.38"	(60.5)	0.375"	(9.5)	2
MA9M8P	9/16"	1/2"	0.88"	(22.4)	2.63"	(66.8)	0.359"	(9.1)	2
MA9M12P	9/16"	3/4"	1.13"	(28.7)	2.88"	(73.2)	0.359"	(9.1)	2
MA9M16P	9/16"	1"	1.38"	(35.1)	2.82"	(71.6)	0.406"	(10.3)	2
MA12M2P	3/4"	1/8"	1.38"	(35.1)	2.75"	(69.9)	0.562"	(14.3)	2
MA12M4P	3/4"	1/4"	1.13"	(28.7)	2.75"	(69.9)	0.250"	(6.4)	1
MA12M6P	3/4"	3/8"	1.13"	(28.7)	3.15"	(80.0)	0.375"	(9.5)	2
MA12M8P	3/4"	1/2"	1.13"	(28.7)	3.40"	(86.4)	0.375"	(9.5)	2
MA12M12P	3/4"	3/4"	1.75"	(44.5)	3.40"	(86.4)	0.250"	(6.4)	2
MA16P12M	3/4"	1"	1.38"	(35.1)	3.29"	(83.6)	0.562"	(14.3)	2
MA16M2P	1"	1/8"	1.38"	(35.1)	3.00"	(76.2)	0.718"	(18.2)	2
MA16M4P	1"	1/4"	1.38"	(35.1)	3.00"	(76.2)	0.250"	(6.4)	1
MA16M6P	1"	3/8"	1.50"	(38.1)	2.50"	(63.5)	0.375"	(9.5)	2
MA16M8P	1"	1/2"	1.38"	(35.1)	3.30"	(83.8)	0.437"	(11.1)	2
MA16M12P	1"	3/4"	1.38"	(35.1)	3.38"	(85.9)	0.500"	(12.7)	1
MA16M16P	1"	1"	1.38"	(35.1)	3.67"	(93.2)	0.562"	(14.3)	2

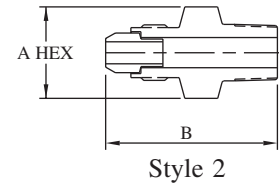
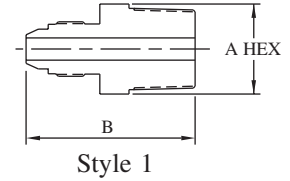

Medium Pressure Male x Medium Pressure Male

Catalog Number	Male M/P	Male M/P	A		B		Port	Style	
MA4M4M	1/4"	1/4"	0.88"	(22.4)	2.25"	(57.2)	0.109"	(2.8)	1
MA4M6M	1/4"	3/8"	0.88"	(22.4)	2.63"	(66.8)	0.109"	(2.8)	3
MA4M9M	1/4"	9/16"	0.88"	(22.4)	2.63"	(66.8)	0.109"	(2.8)	3
MA4M12M	1/4"	3/4"	1.13"	(28.7)	2.75"	(69.9)	0.109"	(2.8)	1
MA6M6M	3/8"	3/8"	0.75"	(19.1)	2.75"	(69.9)	0.250"	(6.4)	2
MA6M16M	3/8"	1"	1.38"	(35.1)	3.15"	(80.0)	0.250"	(6.4)	2
MA9M6M	9/16"	3/8"	1.00"	(25.4)	2.75"	(69.9)	0.250"	(6.4)	2
MA9M9M	9/16"	9/16"	0.88"	(22.4)	3.00"	(76.2)	0.312"	(7.9)	2
MA9M12M	9/16"	3/4"	1.13"	(28.7)	2.86"	(72.6)	0.406"	(10.3)	2
MA9M16M	9/16"	1"	1.38"	(35.1)	3.25"	(82.6)	0.500"	(12.7)	1
MA12M6M	3/4"	3/8"	1.13"	(28.7)	2.74"	(69.6)	0.250"	(6.4)	2
MA12M12M	3/4"	3/4"	1.13"	(28.7)	3.55"	(90.2)	0.516"	(13.1)	2
MA12M16M	3/4"	1"	1.38"	(35.1)	3.50"	(88.9)	0.500"	(12.7)	1
MA16M4M	1"	1/4"	1.38"	(35.1)	3.30"	(83.8)	0.562"	(14.3)	2
MA16M16M	1"	1"	1.38"	(35.1)	4.10"	(104.1)	0.688"	(17.5)	2

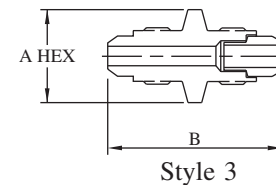
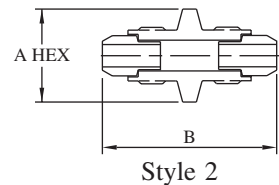
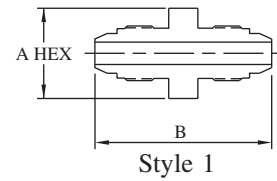

NOTE: See page ACC-1 to determine maximum allowable working pressure (MAWP)



All dimensions are for reference only and are subject to change.
Dimensions in parentheses are millimeters (mm).

MALE-MALE ADAPTERS

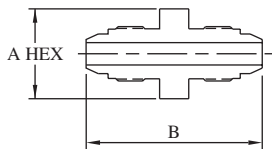

Style 1

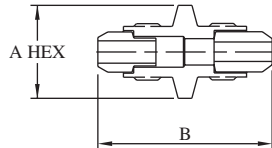

Style 2

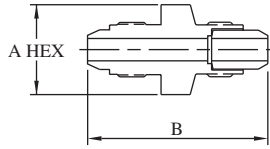

Style 3

Medium Pressure Male x High Pressure Male

Catalog Number	Male M/P	Male H/P	A	B	Port	Style
MA4M4H	1/4"	1/4"	0.88" (22.4)	2.43" (61.7)	0.109" (2.8)	3
MA4M6H	1/4"	3/8"	0.75" (19.1)	2.46" (62.5)	0.109" (2.8)	1
MA4M9H	1/4"	9/16"	1.13" (28.7)	2.50" (63.5)	0.109" (2.8)	3
MA6M4H	3/8"	1/4"	0.75" (19.1)	2.56" (65.0)	0.125" (3.2)	2
MA6M6H	3/8"	3/8"	1.00" (25.4)	2.45" (62.2)	0.250" (6.4)	2
MA6M9H	3/8"	9/16"	1.13" (28.7)	2.99" (75.9)	0.250" (6.4)	2
MA9M4H	9/16"	1/4"	1.00" (25.4)	2.56" (65.0)	0.125" (3.2)	2
MA9M6H	9/16"	3/8"	1.00" (25.4)	2.62" (66.5)	0.218" (5.5)	2
MA9M9H	9/16"	9/16"	1.13" (28.7)	3.18" (80.8)	0.281" (7.1)	2
MA12M4H	3/4"	1/4"	1.38" (35.1)	3.00" (76.2)	0.125" (3.2)	1
MA6H12M	3/4"	3/8"	1.38" (35.1)	2.81" (71.4)	0.125" (3.2)	1
MA12M9H	3/4"	9/16"	1.38" (35.1)	3.00" (76.2)	0.281" (7.1)	2
MA16M4H	1"	1/4"	1.38" (35.1)	3.11" (79.0)	0.125" (3.2)	2
MA16M6H	1"	3/8"	1.38" (35.1)	3.50" (88.9)	0.218" (5.5)	2
MA16M9H	1"	9/16"	1.38" (35.1)	3.61" (91.7)	0.281" (7.1)	2

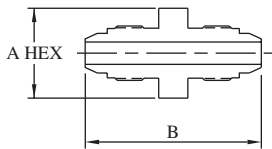

Style 1

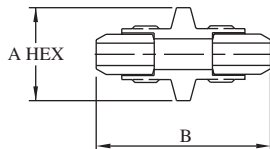

Style 2

High Pressure Male x High Pressure Male

Catalog Number	Male H/P	Male H/P	A	B	Port	Style
MA4H4H	1/4"	1/4"	0.75" (19.1)	2.12" (53.8)	0.125" (3.2)	2
MA6H4H	3/8"	1/4"	0.75" (19.1)	2.42" (61.5)	0.082" (2.1)	1
MA6H6H	3/8"	3/8"	0.75" (19.1)	2.50" (63.5)	0.218" (5.5)	2
MA9H4H	9/16"	1/4"	1.13" (28.7)	2.99" (75.9)	0.125" (3.2)	2
MA9H6H	9/16"	3/8"	1.18" (30.0)	3.06" (77.7)	0.218" (5.5)	2
MA9H9H	9/16"	9/16"	1.18" (30.0)	3.37" (85.6)	0.218" (5.5)	2

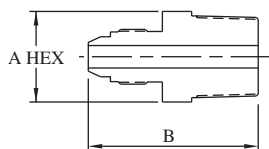

Style 1

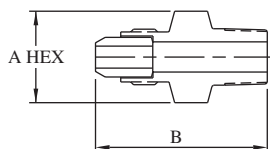

Style 2

High Pressure Male x NPT Male

Catalog Number	Male H/P	Male NPT	A	B	Port	Style
MA4H2P	1/4"	1/8"	1.00" (25.4)	2.18" (55.4)	0.125" (3.2)	1
MA4H4P	1/4"	1/4"	1.00" (25.4)	2.18" (55.4)	0.125" (3.2)	2
MA4H6P	1/4"	3/8"	0.75" (19.1)	1.86" (47.2)	0.125" (3.2)	2
MA4H8P	1/4"	1/2"	1.00" (25.4)	2.18" (55.4)	0.125" (3.2)	2
MA4H12P	1/4"	3/4"	1.38" (35.1)	2.18" (55.4)	0.125" (3.2)	2
MA4H16P	1/4"	1"	1.38" (35.1)	2.68" (68.1)	0.125" (3.2)	2
MA6H2P	3/8"	1/8"	1.00" (25.4)	2.75" (69.9)	0.188" (4.8)	2
MA6H4P	3/8"	1/4"	1.00" (25.4)	2.75" (69.9)	0.218" (5.5)	2
MA6H6P	3/8"	3/8"	0.81" (20.6)	2.19" (55.6)	0.218" (5.5)	2
MA6H8P	3/8"	1/2"	1.00" (25.4)	3.00" (76.2)	0.125" (3.2)	1
MA6H12P	3/8"	3/4"	1.13" (28.7)	3.00" (76.2)	0.218" (5.5)	2
MA6H16P	3/8"	1"	1.13" (28.7)	3.00" (76.2)	0.218" (5.5)	2
MA9H2P	9/16"	1/8"	1.13" (28.7)	3.00" (76.2)	0.188" (4.8)	2
MA9H4P	9/16"	1/4"	1.13" (28.7)	2.81" (71.4)	0.250" (6.4)	2
MA9H6P	9/16"	3/8"	1.13" (28.7)	2.81" (71.4)	0.281" (7.1)	2
MA9H8P	9/16"	1/2"	1.18" (30.0)	3.00" (76.2)	0.281" (7.1)	2
MA9H12P	9/16"	3/4"	1.13" (28.7)	2.63" (66.8)	0.281" (7.1)	2
MA9H16P	9/16"	1"	1.38" (35.1)	3.00" (76.2)	0.281" (7.1)	2

NOTE: See page ACC-1 to determine maximum allowable working pressure (MAWP)

All dimensions are for reference only and are subject to change.
Dimensions in parentheses are millimeters (mm).

FEMALE-FEMALE COUPLINGS

Low Pressure Female x Low Pressure Female

Catalog Number	Female L/P	Female L/P	A		B		Port	
LPC2L4L	1/8"	1/4"	0.75"	(19.1)	1.50"	(38.1)	0.093"	(2.4)
LPC2L6L	1/8"	3/8"	0.75"	(19.1)	1.75"	(44.5)	0.093"	(2.4)
LPC2L8L	1/8"	1/2"	1.00"	(25.4)	2.00"	(50.8)	0.093"	(2.4)
LPC4L6L	1/4"	3/8"	0.75"	(19.1)	1.75"	(44.5)	0.187"	(4.7)
LPC4L8L	1/4"	1/2"	1.00"	(25.4)	2.00"	(50.8)	0.187"	(4.7)
LPC6L8L	3/8"	1/2"	1.00"	(25.4)	2.00"	(50.8)	0.312"	(7.9)

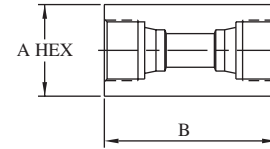

Low Pressure Female x High Pressure Female

Catalog Number	Female L/P	Female H/P	A		B		Port	
LPC2L4H	1/8"	1/4"	0.75"	(19.1)	1.50"	(38.1)	0.093"	(2.4)
LPC2L6H	1/8"	3/8"	1.00"	(25.4)	2.00"	(50.8)	0.093"	(2.4)
LPC2L9H	1/8"	9/16"	1.38"	(35.1)	2.25"	(57.2)	0.093"	(2.4)
LPC4L4H	1/4"	1/4"	0.75"	(19.1)	1.50"	(38.1)	0.093"	(2.4)
LPC4L6H	1/4"	3/8"	1.00"	(25.4)	1.75"	(44.5)	0.125"	(3.2)
LPC4L9H	1/4"	9/16"	1.38"	(35.1)	2.25"	(57.2)	0.187"	(4.7)
LPC6L4H	3/8"	1/4"	0.75"	(19.1)	1.50"	(38.1)	0.093"	(2.4)
LPC6L6H	3/8"	3/8"	1.00"	(25.4)	1.75"	(44.5)	0.125"	(3.2)
LPC6L9H	3/8"	9/16"	1.38"	(35.1)	2.25"	(57.2)	0.187"	(4.7)
LPC8L4H	1/2"	1/4"	1.00"	(25.4)	1.62"	(41.1)	0.093"	(2.4)
LPC8L6H	1/2"	3/8"	1.38"	(35.1)	2.00"	(50.8)	0.125"	(3.2)
LPC8L9H	1/2"	9/16"	1.38"	(35.1)	2.25"	(57.2)	0.187"	(4.7)

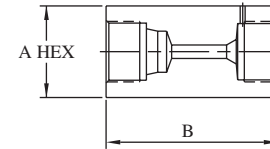

Low Pressure Female x Medium Pressure Female

Catalog Number	Female L/P	Female M/P	A		B		Port	
LPC2L4M	1/8"	1/4"	0.75"	(19.1)	1.50"	(38.1)	0.093"	(2.4)
LPC2L6M	1/8"	3/8"	1.00"	(25.4)	1.50"	(38.1)	0.093"	(2.4)
LPC2L9M	1/8"	9/16"	1.00"	(25.4)	2.00"	(50.8)	0.093"	(2.4)
LPC4L4M	1/4"	1/4"	0.75"	(19.1)	1.50"	(38.1)	0.103"	(2.6)
LPC4L6M	1/4"	3/8"	0.75"	(19.1)	1.75"	(44.5)	0.203"	(5.2)
LPC4L9M	1/4"	9/16"	1.00"	(25.4)	2.00"	(50.8)	0.187"	(4.7)
LPC6L4M	3/8"	1/4"	0.75"	(19.1)	1.50"	(38.1)	0.103"	(2.6)
LPC6L6M	3/8"	3/8"	0.75"	(19.1)	1.75"	(44.5)	0.203"	(5.2)
LPC6L9M	3/8"	9/16"	1.00"	(25.4)	2.00"	(50.8)	0.312"	(7.9)
LPC6L12M	3/8"	3/4"	1.38"	(35.1)	2.50"	(63.5)	0.312"	(7.9)
LPC8L4M	1/2"	1/4"	0.75"	(19.1)	2.00"	(50.8)	0.103"	(2.6)
LPC8L6M	1/2"	3/8"	1.00"	(25.4)	2.00"	(50.8)	0.203"	(5.2)
LPC8L9M	1/2"	9/16"	1.00"	(25.4)	2.00"	(50.8)	0.359"	(9.1)
LPC8L12M	1/2"	3/4"	1.38"	(35.1)	2.50"	(63.5)	0.437"	(11.1)

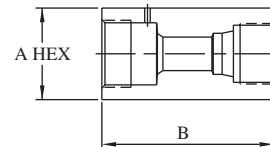

NOTE: See page ACC-1 to determine maximum allowable working pressure (MAWP)



All dimensions are for reference only and are subject to change.
Dimensions in parentheses are millimeters (mm).

FEMALE-FEMALE COUPLINGS

Low Pressure Female x NPT Female

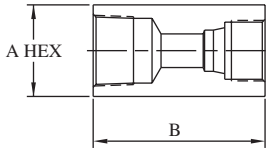

Catalog Number	Female L/P	Female NPT	A		B		Port	
LPC2L2P	1/8"	1/8"	0.50"	(12.7)	1.50"	(38.1)	0.093"	(2.4)
LPC2L4P	1/8"	1/4"	0.75"	(19.1)	1.50"	(38.1)	0.093"	(2.4)
LPC2L6P	1/8"	3/8"	1.00"	(25.4)	1.56"	(39.6)	0.093"	(2.4)
LPC2L8P	1/8"	1/2"	1.38"	(35.1)	2.00"	(50.8)	0.093"	(2.4)
LPC4L2P	1/4"	1/8"	0.75"	(19.1)	1.75"	(44.5)	0.187"	(4.7)
LPC4L4P	1/4"	1/4"	0.75"	(19.1)	1.50"	(38.1)	0.187"	(4.7)
LPC4L6P	1/4"	3/8"	1.00"	(25.4)	2.12"	(53.8)	0.187"	(4.7)
LPC4L8P	1/4"	1/2"	1.38"	(35.1)	2.00"	(50.8)	0.187"	(4.7)
LPC6L2P	3/8"	1/8"	0.75"	(19.1)	1.62"	(41.1)	0.187"	(4.7)
LPC6L4P	3/8"	1/4"	0.75"	(19.1)	1.62"	(41.1)	0.312"	(7.9)
LPC6L6P	3/8"	3/8"	1.00"	(25.4)	1.75"	(44.5)	0.312"	(7.9)
LPC6L8P	3/8"	1/2"	1.38"	(35.1)	2.25"	(57.2)	0.312"	(7.9)
LPC8L2P	1/2"	1/8"	1.00"	(25.4)	2.00"	(50.8)	0.339"	(8.6)
LPC8L4P	1/2"	1/4"	1.00"	(25.4)	2.00"	(50.8)	0.437"	(11.1)
LPC8L6P	1/2"	3/8"	1.00"	(25.4)	2.00"	(50.8)	0.437"	(11.1)
LPC8L8P	1/2"	1/2"	1.00"	(25.4)	2.00"	(50.8)	0.437"	(11.1)
LPC8L12P	1/2"	3/4"	1.75"	(44.5)	2.50"	(63.5)	0.437"	(11.1)

Medium Pressure Female x NPT Female

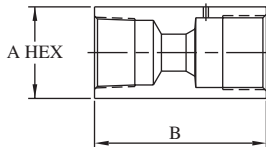

Catalog Number	Female M/P	Female NPT	A		B		Port	
10F4M2P	1/4"	1/8"	0.75"	(19.1)	1.50"	(38.1)	0.109"	(2.8)
10F4M4P	1/4"	1/4"	0.75"	(19.1)	1.50"	(38.1)	0.125"	(3.2)
10F4M6P	1/4"	3/8"	1.00"	(25.4)	1.62"	(41.1)	0.125"	(3.2)
10F4M8P	1/4"	1/2"	1.38"	(35.1)	2.12"	(53.8)	0.125"	(3.2)
10F6M2P	3/8"	1/8"	0.75"	(19.1)	1.75"	(44.5)	0.203"	(5.2)
10F6M4P	3/8"	1/4"	0.75"	(19.1)	1.75"	(44.5)	0.203"	(5.2)
10F6M6P	3/8"	3/8"	1.00"	(25.4)	1.68"	(42.7)	0.203"	(5.2)
10F6M8P	3/8"	1/2"	1.38"	(35.1)	2.12"	(53.8)	0.203"	(5.2)
10F9M2P	9/16"	1/8"	1.00"	(25.4)	2.00"	(50.8)	0.339"	(8.6)
10F9M4P	9/16"	1/4"	1.00"	(25.4)	2.00"	(50.8)	0.359"	(9.1)
10F9M6P	9/16"	3/8"	1.00"	(25.4)	2.00"	(50.8)	0.359"	(9.1)
10F9M8P	9/16"	1/2"	1.38"	(35.1)	2.25"	(57.2)	0.359"	(9.1)
10F9M12P	9/16"	3/4"	1.75"	(44.5)	2.50"	(63.5)	0.359"	(9.1)
10F9M16P	9/16"	1"	1.88"	(47.8)	2.44"	(62.0)	0.359"	(9.1)
10F12M2P	3/4"	1/8"	1.38"	(35.1)	2.50"	(63.5)	0.339"	(8.6)
10F12M4P	3/4"	1/4"	1.38"	(35.1)	2.50"	(63.5)	0.437"	(11.1)
10F12M6P	3/4"	3/8"	1.38"	(35.1)	2.50"	(63.5)	0.516"	(13.1)
10F12M8P	3/4"	1/2"	1.38"	(35.1)	2.50"	(63.5)	0.516"	(13.1)
10F12M12P	3/4"	3/4"	1.75"	(44.5)	2.50"	(63.5)	0.516"	(13.1)
10F12M16P	3/4"	1"	2.13"	(54.1)	2.75"	(69.9)	0.516"	(13.1)
10F16M2P	1"	1/8"	1.75"	(44.5)	3.00"	(76.2)	0.339"	(8.6)
10F16M4P	1"	1/4"	1.75"	(44.5)	3.00"	(76.2)	0.437"	(11.1)
10F16M6P	1"	3/8"	1.75"	(44.5)	3.00"	(76.2)	0.578"	(14.7)
10F16M8P	1"	1/2"	1.75"	(44.5)	3.00"	(76.2)	0.687"	(17.4)
10F16M12P	1"	3/4"	1.75"	(44.5)	3.00"	(76.2)	0.687"	(17.4)
10F16M16P	1"	1"	2.13"	(54.1)	3.50"	(88.9)	0.687"	(17.4)

NOTE: See page ACC-1 to determine maximum allowable working pressure (MAWP)

All dimensions are for reference only and are subject to change.
Dimensions in parentheses are millimeters (mm).

FEMALE-FEMALE COUPLINGS

High Pressure Female x NPT Female

Catalog Number	Female H/P	Female NPT	A		B		Port	
10F4H2P	1/4"	1/8"	0.75"	(19.1)	1.50"	(38.1)	0.093"	(2.4)
10F4H4P	1/4"	1/4"	0.75"	(19.1)	1.50"	(38.1)	0.093"	(2.4)
10F4H6P	1/4"	3/8"	1.00"	(25.4)	1.62"	(41.1)	0.093"	(2.4)
10F4H8P	1/4"	1/2"	1.38"	(35.1)	2.12"	(53.8)	0.093"	(2.4)
10F6H2P	3/8"	1/8"	1.00"	(25.4)	1.75"	(44.5)	0.125"	(3.2)
10F6H4P	3/8"	1/4"	1.00"	(25.4)	1.75"	(44.5)	0.125"	(3.2)
10F6H6P	3/8"	3/8"	1.00"	(25.4)	1.75"	(44.5)	0.125"	(3.2)
10F6H8P	3/8"	1/2"	1.38"	(35.1)	2.12"	(53.8)	0.125"	(3.2)
10F9H2P	9/16"	1/8"	1.38"	(35.1)	2.25"	(57.2)	0.187"	(4.7)
10F9H4P	9/16"	1/4"	1.38"	(35.1)	2.25"	(57.2)	0.187"	(4.7)
10F9H6P	9/16"	3/8"	1.38"	(35.1)	2.25"	(57.2)	0.187"	(4.7)
10F9H8P	9/16"	1/2"	1.38"	(35.1)	2.25"	(57.2)	0.187"	(4.7)
10F9H12P	9/16"	3/4"	1.38"	(35.1)	2.50"	(63.5)	0.187"	(4.7)

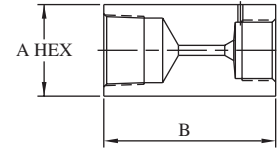

Medium Pressure Female x Medium Pressure Female

Catalog Number	Female M/P	Female M/P	A		B		Port	
20F4M6M	1/4"	3/8"	0.75"	(19.1)	1.75"	(44.5)	0.109"	(2.8)
20F4M9M	1/4"	9/16"	1.00"	(25.4)	2.00"	(50.8)	0.109"	(2.8)
20F4M12M	1/4"	3/4"	1.38"	(35.1)	2.50"	(63.5)	0.109"	(2.8)
20F4M16M	1/4"	1"	1.75"	(44.5)	3.00"	(76.2)	0.109"	(2.8)
20F6M9M	3/8"	9/16"	1.00"	(25.4)	2.00"	(50.8)	0.203"	(5.2)
20F6M12M	3/8"	3/4"	1.38"	(35.1)	2.50"	(63.5)	0.203"	(5.2)
20F6M16M	3/8"	1"	1.75"	(44.5)	3.00"	(76.2)	0.203"	(5.2)
20F9M12M	9/16"	3/4"	1.38"	(35.1)	2.50"	(63.5)	0.312"	(7.9)
20F9M16M	9/16"	1"	1.75"	(44.5)	3.00"	(76.2)	0.359"	(9.1)
20F12M16M	3/4"	1"	1.75"	(44.5)	3.00"	(76.2)	0.516"	(13.1)

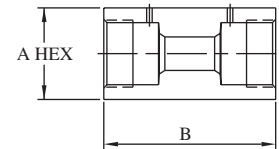

Medium Pressure Female x High Pressure Female

Catalog Number	Female M/P	Female H/P	A		B		Port	
20F4M4H	1/4"	1/4"	0.75"	(19.1)	1.50"	(38.1)	0.093"	(2.4)
20F4M6H	1/4"	3/8"	1.00"	(25.4)	1.75"	(44.5)	0.109"	(2.8)
20F4M9H	1/4"	9/16"	1.38"	(35.1)	2.25"	(57.2)	0.109"	(2.8)
20F6M4H	3/8"	1/4"	0.75"	(19.1)	1.75"	(44.5)	0.093"	(2.4)
20F6M6H	3/8"	3/8"	1.00"	(25.4)	1.75"	(44.5)	0.125"	(3.2)
20F6M9H	3/8"	9/16"	1.38"	(35.1)	2.25"	(57.2)	0.187"	(4.7)
20F9M4H	9/16"	1/4"	1.00"	(25.4)	2.00"	(50.8)	0.093"	(2.4)
20F9M6H	9/16"	3/8"	1.00"	(25.4)	2.00"	(50.8)	0.125"	(3.2)
20F9M9H	9/16"	9/16"	1.38"	(35.1)	2.25"	(57.2)	0.187"	(4.7)
20F12M4H	3/4"	1/4"	1.38"	(35.1)	2.50"	(63.5)	0.093"	(2.4)
20F12M6H	3/4"	3/8"	1.38"	(35.1)	2.50"	(63.5)	0.125"	(3.2)
20F12M9H	3/4"	9/16"	1.38"	(35.1)	2.50"	(63.5)	0.187"	(4.7)
20F16M4H	1"	1/4"	1.75"	(44.5)	3.00"	(76.2)	0.093"	(2.4)
20F16M6H	1"	3/8"	1.75"	(44.5)	3.00"	(76.2)	0.125"	(3.2)
20F16M9H	1"	9/16"	1.75"	(44.5)	3.00"	(76.2)	0.187"	(4.7)

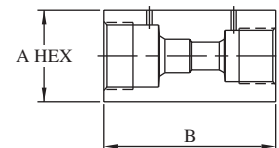

High Pressure Female x High Pressure Female

Catalog Number	Female H/P	Female H/P	A		B		Port	
60F4H6H	1/4"	3/8"	1.00"	(25.4)	1.75"	(44.5)	0.093"	(2.4)
60F4H9H	1/4"	9/16"	1.38"	(35.1)	2.25"	(57.2)	0.093"	(2.4)
60F6H9H	3/8"	9/16"	1.38"	(35.1)	2.25"	(57.2)	0.125"	(3.2)

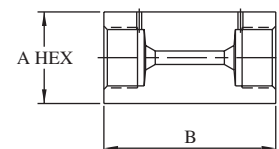

NOTE: See page ACC-1 to determine maximum allowable working pressure (MAWP)



All dimensions are for reference only and are subject to change.
Dimensions in parentheses are millimeters (mm).

HIGH PRESSURE HOSE

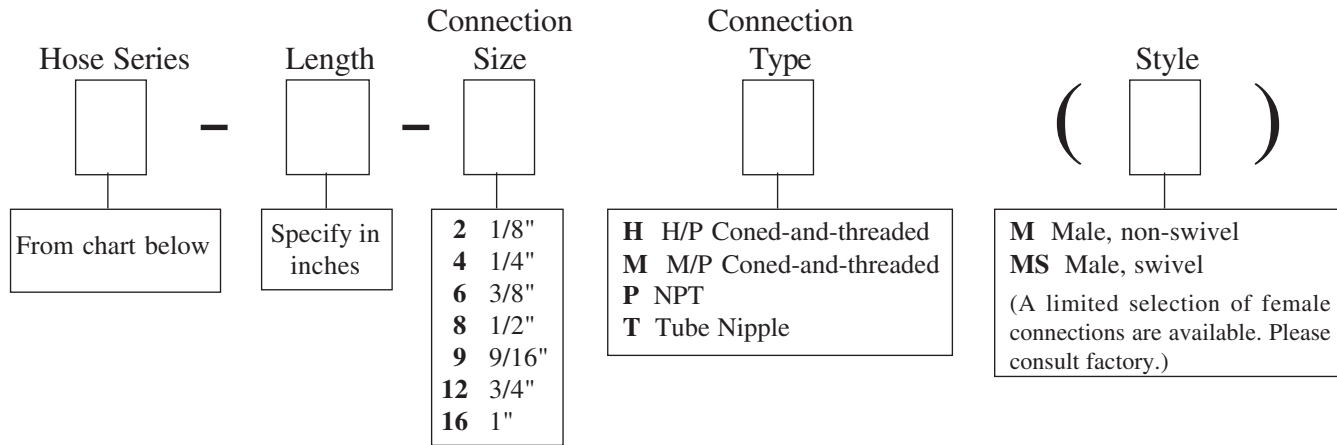

Example:

16.4H-.25-120-8P (M x MS) specifies a 0.25" ID Hose rated 16,400 PSI, 120" long, with 1/2" NPT connections, one end swivel.

BuTech offers a variety of high pressure hose for waterjet cutting, high pressure testing and hydraulics.

Outer covers are manufactured from Extruded Nylon 11 or can be specified in polyurethane. Hose cores are Nylon 11 with one braided plus two spiral wound layers of plated high strength steel wire for pressure support, or Delrin or Nylon 11 with four spiral wound layers of plated high strength steel wire for pressure support.

All hose assemblies are tested to 1.5 x Working pressure and are available with choice of female or male NPT end connections in 1/8", 1/4", 3/8", 1/2", 3/4", and 1" sizes. Operating temperature range is -40° to +140°F (-40° to 60°C).



Hose Series	Working Pressure		Hose I.D.		Hose O.D.		Insert I.D.	
	PSI	bar	Inches	MM	Inches	MM	Inches	MM
6.4H-1.00	6,400	440	1.00	25.4	1.34	34.0	0.72	18.3
6.5H-1.00	6,500	450	1.00	25.4	1.37	34.8	0.69	17.5
8H-.14	8,000	550	0.14	3.6	0.27	6.9	0.07	1.8
8.1H-.81	8,100	560	0.81	20.6	1.14	29.0	0.56	14.2
8.4H-.50	8,400	580	0.50	12.7	0.81	20.6	0.35	8.9
9.28H-.11	9,280	640	0.11	2.8	0.23	5.8	0.08	2.0
10.3H-.40	10,300	710	0.40	10.2	0.70	17.8	0.23	5.8
10.4H-.25	10,400	720	0.25	6.4	0.50	12.7	0.17	4.3
10.4H-.50	10,400	720	0.50	12.7	0.81	20.6	0.35	8.9
12H-.25	12,000	830	0.25	6.4	0.52	13.2	0.13	3.3
12.4H-.50	12,400	850	0.50	12.7	0.87	22.1	0.35	8.9
13.05H-1.00	13,050	900	1.00	25.4	1.46	37.1	0.69	17.5
13.2H-.25	13,200	910	0.25	6.4	0.50	12.7	0.17	4.3
13.6H-.32	13,600	940	0.32	8.1	0.62	15.7	0.18	4.6
14H-.25	14,000	970	0.25	6.4	0.50	12.7	0.17	4.3
15H-.17	15,000	1030	0.17	4.3	0.31	7.9	0.10	2.5
15H-.20	15,000	1030	0.20	5.1	0.42	10.7	0.13	3.3
15H-.81	15,000	1030	0.81	20.6	1.19	30.2	0.53	13.5
16.4H-.25	16,400	1130	0.25	6.4	0.54	13.7	0.13	3.3
17.4H-.16	17,400	1200	0.16	4.1	0.39	9.9	0.08	2.0
20.3H-.80	20,300	1400	0.80	20.3	1.30	33.0	0.53	13.5
20.4H-.50	20,400	1410	0.50	12.7	0.88	22.4	0.30	7.6
22.5H-.25	22,500	1550	0.25	6.4	0.50	12.7	0.13	3.3
23H-.33	23,000	1590	0.33	8.4	0.61	15.5	0.18	4.6
26H-.20	26,000	1790	0.20	5.1	0.43	10.9	0.07	1.8
26H-.50	26,000	1790	0.50	12.7	0.97	24.6	0.31	7.9
30H-.15	30,000	2070	0.15	3.8	0.37	9.4	0.10	2.5
36H-.33	36,000	2480	0.33	8.4	0.68	17.3	0.18	4.6
36.25H-.20	36,250	2500	0.20	5.1	0.50	12.7	0.09	2.3
40H-.20	40,000	2760	0.20	5.1	0.50	12.7	0.09	2.3
40.6H-.15	40,600	2800	0.15	3.8	0.42	10.7	0.08	2.0
48H-.20	48,000	3310	0.20	5.1	0.57	14.5	0.08	2.0
60H-.20	60,000	4140	0.20	5.1	1.57	39.9	0.08	2.0

All dimensions are for reference only and are subject to change.
Dimensions in parentheses are millimeters (mm).

THERMOCOUPLES & GAUGE SNUBBERS

BuTech Thermocouples permit quick and accurate temperature monitoring at any point in the system. Sheath lengths are standardized for use with any tee or cross shown in this catalog. To order custom lengths, add the desired length to the catalog number. (Example: 20TCJ6-8" would be an 8" sheath length that would fit into the standard 3/8" M/P connection.)



- Standard quick connectors, both male and female, supplied with thermocouple
- Small diameter sheath to give fast response time
- Sheath has grounded junction
- 300 series SS sheath standard, other materials available on request
- Can be directly installed into any standard tee or cross.
- Working pressures to 60,000 PSI (4140 bar)
- 1/4" thermocouple supplied complete with collar and gland; other sizes supplied complete with 316SS adapter and necessary collars and glands to fit into standard connection.
- Standard thermocouples available with either type J or type K calibration. Other types available on special order.
- Temperature at the tip of the thermocouple can range to 2,000°F (1093°C)

Connection	Catalog Number		MAWP
	Type J Calibration	Type K Calibration	
1/4" M/P	20TCJ4	20TCK4	20,000 PSI 1380 bar
3/8" M/P	20TCJ6	20TCK6	20,000 PSI 1380 bar
9/16" M/P	20TCJ9	20TCK9	20,000 PSI 1380 bar
3/4" M/P	20TCJ12	20TCK12	20,000 PSI 1380 bar
1" M/P	20TCJ16	20TCK16	20,000 PSI 1380 bar
1/4" H/P	60TCJ4	60TCK4	60,000 PSI 4140 bar
3/8" H/P	60TCJ6	60TCK6	60,000 PSI 4140 bar
9/16" H/P	60TCJ9	60TCK9	60,000 PSI 4140 bar

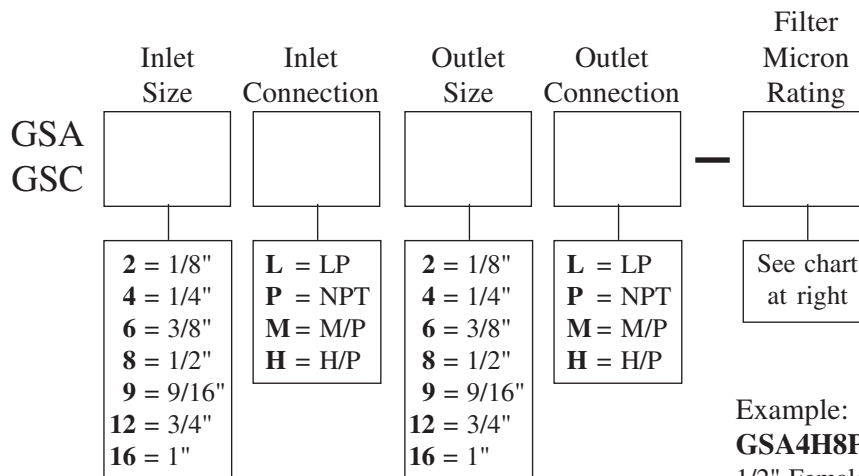

Micron Rating	Service Recommendations	Replacement Disc P/N
2	Gases, Severe Pulsing	PH-1103
5	Air, Gases, Vapors	PH-1104
10	Water, Light Oils	PH-1105
20	Heavy Oils	PH-1021

Example:
GSA4H8P-5 specifies a snubber with 1/4" H/P Male inlet and 1/2" Female NPT outlet with a 5 micron disc

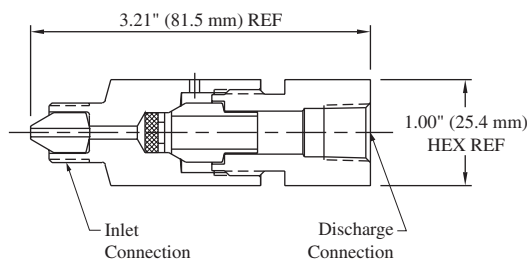

BuTech Gauge Snubbers protect gauges and instruments from pressure surges and shock. This is accomplished through the use of porous sintered 316 stainless steel filter discs. BuTech gauge snubbers are available with a wide variety of connection configurations for pressures up to 60,000 PSI @ 72°F (4140 bar @ 22°C). **GSA** series has a male inlet with a female outlet, **GSC** series has female inlet and outlet.



All dimensions are for reference only and are subject to change.
Dimensions in parentheses are millimeters (mm).



PRESSURE GAUGES

BuTech offers a line of gauges for indication of system pressure. All gauges are supplied with 1/4" H/P Coned and Threaded connections. Various adapters are available for use with medium and high pressure component systems.

Design Features

- Designed to Class AA standards: 1/4 of 1% accuracy
- Impact resistant aluminum case
- Black epoxy finish
- Solid front provides maximum safety with a solid wall between the Bourdon tube and window
- Blowout disc covers entire rear of gauge for pressure relief should Bourdon tube fail
- 316SS Bourdon tube and socket
- Other materials are available on request

Options

- Electric Contact Face - Add **-ECF** to catalog number
- Liquid Filled - Add **-LF** to catalog number

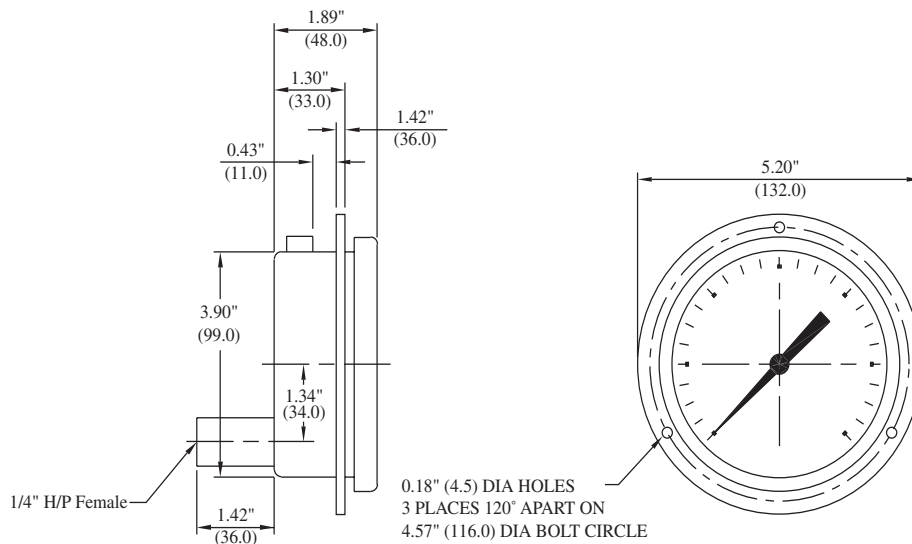

Pressure Range	Pressure Divisions	Bottom Connected Gauges		Back Connected Gauges	
		Wall Mount	Flush Mount	Wall Mount	Flush Mount
1,000 PSI 70 bar	10 PSI 0.7 bar	1MG	1MG-PM	1MGB	1MGB-PM
2,000 PSI 140 bar	20 PSI 1.4 bar	2MG	2MG-PM	2MGB	2MGB-PM
3,000 PSI 210 bar	25 PSI 1.7 bar	3MG	3MG-PM	3MGB	3MGB-PM
5,000 PSI 340 bar	50 PSI 3.4 bar	5MG	5MG-PM	5MGB	5MGB-PM
7,500 PSI 520 bar	50 PSI 3.4 bar	7.5MG	7.5MG-PM	7.5MGB	7.5MGB-PM
10,000 PSI 690 bar	100 PSI 6.9 bar	10MG	10MG-PM	10MGB	10MGB-PM

All dimensions are for reference only and are subject to change.
Dimensions in parentheses are millimeters (mm).

PRESSURE GAUGES

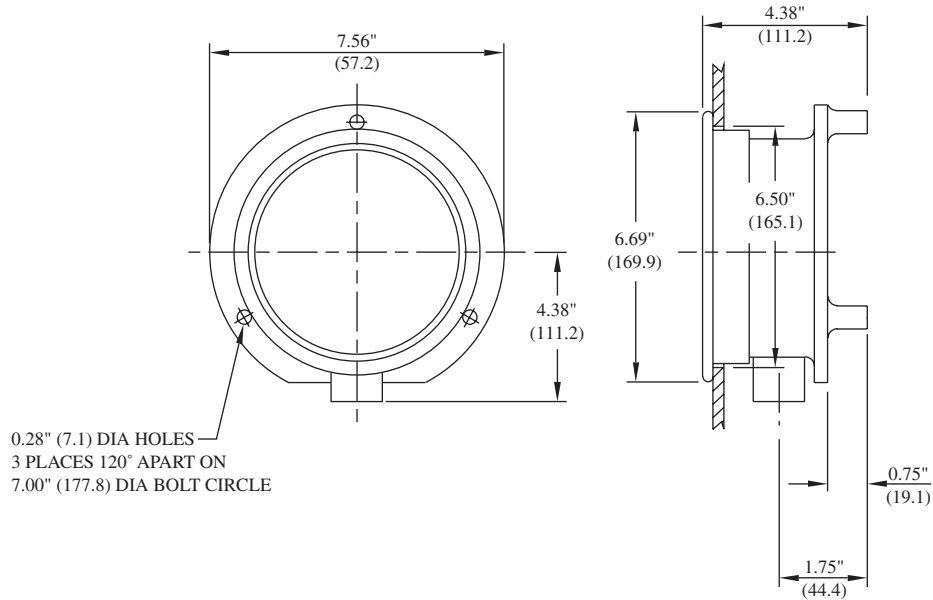

Pressure Range	Pressure Divisions	Bottom Connected Gauges		Back Connected Gauges	
		Wall Mount	Flush Mount	Wall Mount	Flush Mount
15,000 PSI 1030 bar	100 PSI 7 bar	15AG	15AG-PM	15AGB	15AGB-PM
20,000 PSI 1380 bar	200 PSI 14 bar	20AG	20AG-PM	20AGB	20AGB-PM
30,000 PSI 2070 bar	250 PSI 17 bar	30AG	30AG-PM	30AGB	30AGB-PM
50,000 PSI 3450 bar	500 PSI 34 bar	50AG	50AG-PM	50AGB	50AGB-PM
75,000 PSI 5170 bar	500 PSI 34 bar	75AG	75AG-PM	75AGB	75AGB-PM
100,000 PSI 6890 bar	1,000 PSI 69 bar	100AG	100AG-PM	100AGB	100AGB-PM

All dimensions are for reference only and are subject to change.
Dimensions in parentheses are millimeters (mm).



