

Haskel

Q-DRIVE



ADVANCED TRANSFER AND COMPRESSION TECHNOLOGY

Designed with smart electric servo drive technology, Q-Drive is built to offer optimal performance and high flow rates.

- Clean, quiet compression
- Smart, virtual self-diagnostics
- Infinite controllability
- Energy efficient

Available in six models, this breakthrough compression technology is smart, clean and delivers unmatched efficiency

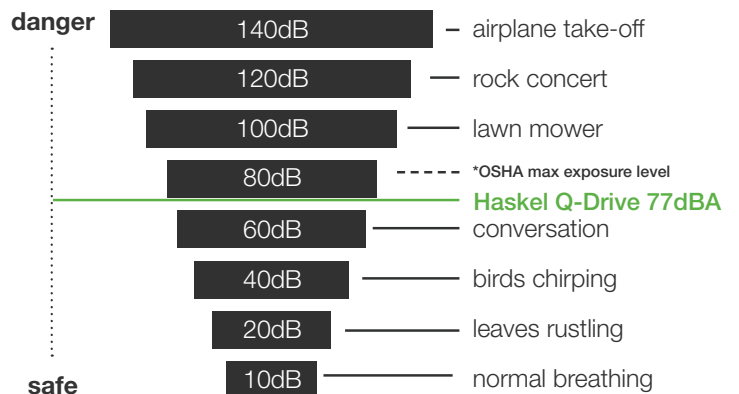

*OSHA recommends that employees not be exposed to noise levels greater than 85dBA

USER INTERFACE

Advanced Monitoring & Diagnostics

Q-Drive's user interface optimizes operational user capabilities and safety and improves gas booster functionality.

Q-Drive's intuitive design features smart controls that allow for increased visibility of the system's operations. The fully digital user interface can be programmed for maximum efficiency and allows operators to set parameters, adjusting settings as needed for improved performance. The remote access capability allows for quick and easy access to diagnostics and troubleshooting. This reduces the costly and time consuming process of technical service in the field and system downtimes. The system's predictive maintenance feature delivers automated maintenance reminders to ensure top performance.

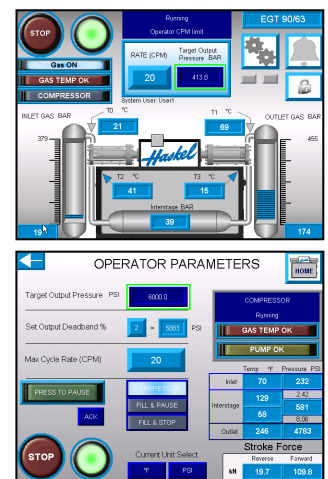

PERFORMANCE BY MODEL

These performance values are only estimates. Actual system performance depends on several different items, including: type of gas, temperature of gas, temperature and flow rate of coolant. If the system temperature gets too high, Q-Drive control will automatically reduce the speed of the system. Please contact a Haskel Applications Engineer with your specific system requirements to determine which configuration is best for your specific application and for an application-specific performance estimate.

QGT-90/63

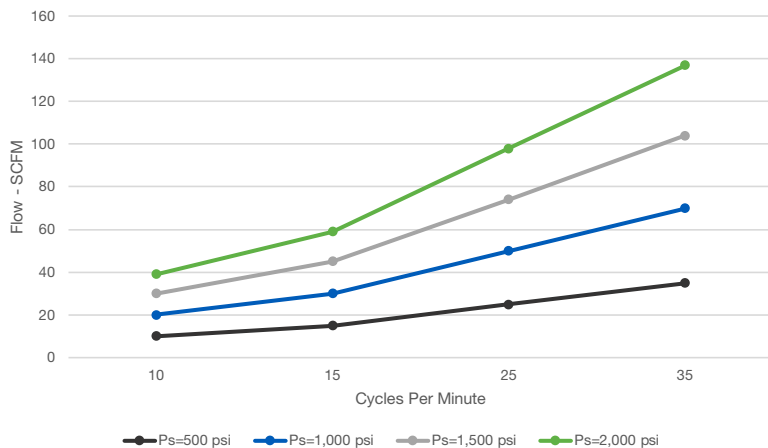

Output Performance

Minimum Gas Inlet (Ps).....75 psig
 Maximum Gas Inlet (Ps).....2,000 psig
 Maximum Gas Outlet (Po).....6,500 psig
 Maximum Gas Compression Ratio....25:1

QGT-150/63

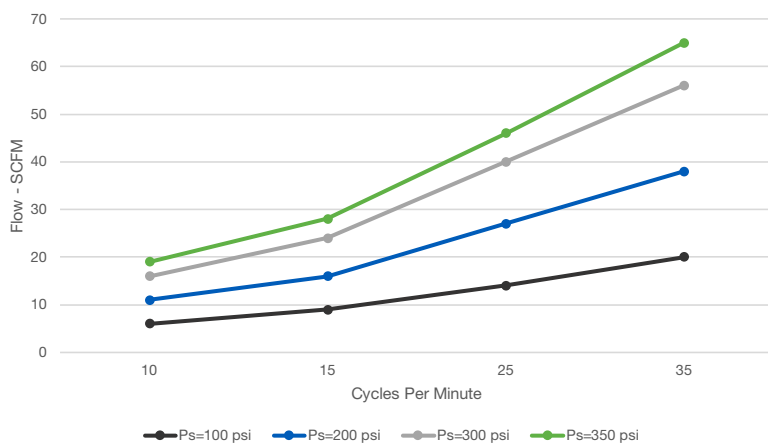

Output Performance

Minimum Gas Inlet (Ps).....75 psig
 Maximum Gas Inlet (Ps).....350 psig
 Maximum Gas Outlet (Po).....6,500 psig
 Maximum Gas Compression Ratio....25:1

QGT-150/90

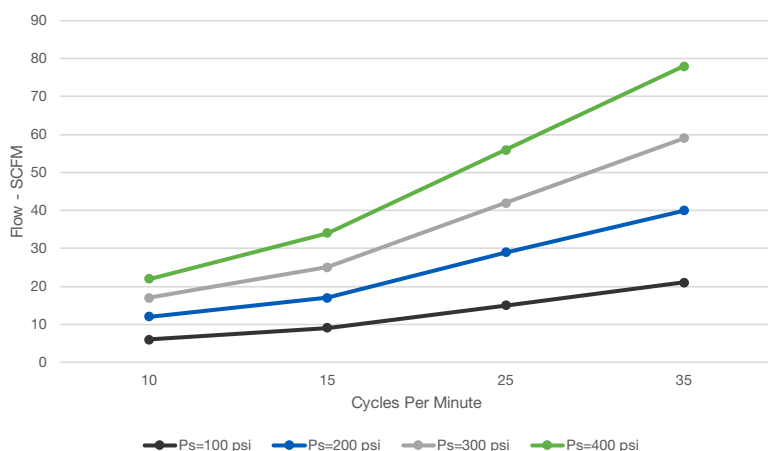

Output Performance

Minimum Gas Inlet (Ps).....75 psig
 Maximum Gas Inlet (Ps).....400 psig
 Maximum Gas Outlet (Po).....3,800 psig
 Maximum Gas Compression Ratio....25:1

PERFORMANCE BY MODEL

These performance values are only estimates. Actual system performance depends on several different items, including: type of gas, temperature of gas, temperature and flow rate of coolant. If the system temperature gets too high, Q-Drive control will automatically reduce the speed of the system. Please contact a Haskell Applications Engineer with your specific system requirements to determine which configuration is best for your specific application and for an application-specific performance estimate.

QGD-63

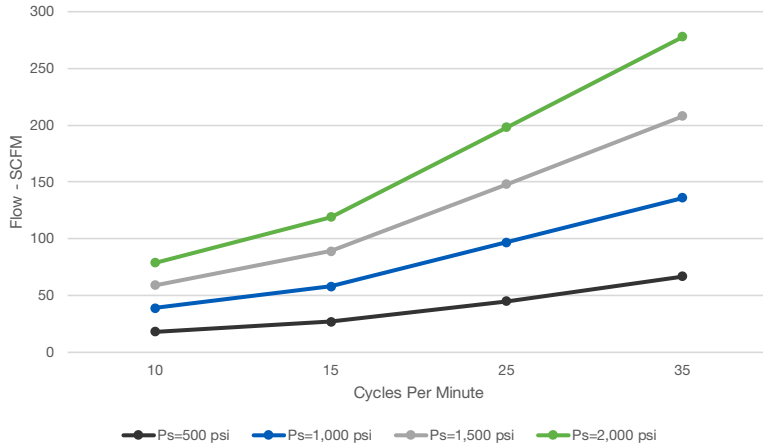

Output Performance

Minimum Gas Inlet (Ps).....75 psig
 Maximum Gas Inlet (Ps).....6,500 psig
 Maximum Gas Outlet (Po).....6,500 psig
 Maximum Gas Compression Ratio.....5:1

QGD-90

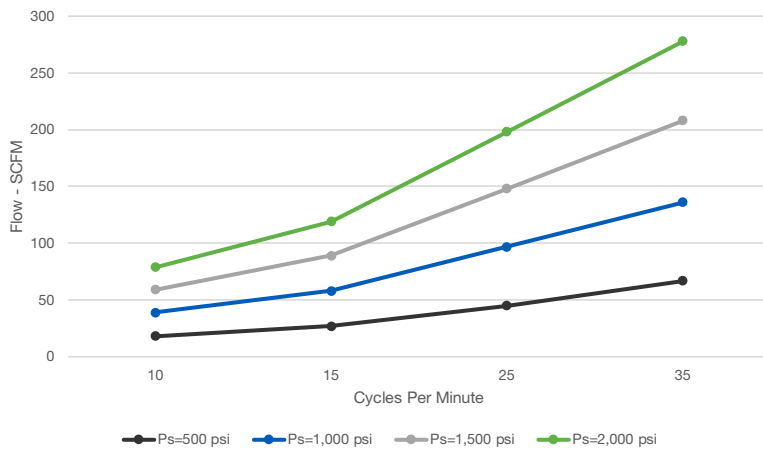

Output Performance

Minimum Gas Inlet (Ps).....75 psig
 Maximum Gas Inlet (Ps).....3,850 psig
 Maximum Gas Outlet (Po).....3,850 psig
 Maximum Gas Compression Ratio.....5:1

QGD-150

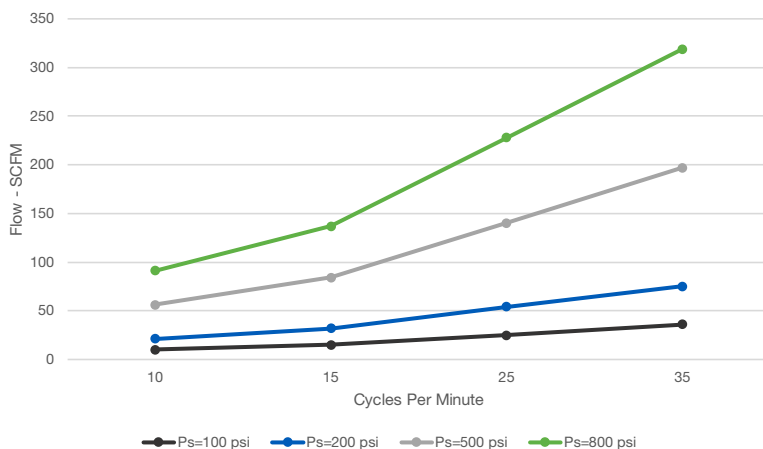

Output Performance

Minimum Gas Inlet (Ps).....75 psig
 Maximum Gas Inlet (Ps).....1,250 psig
 Maximum Gas Outlet (Po).....1,250 psig
 Maximum Gas Compression Ratio.....5:1

PART NUMBER NOMENCLATURE

QGD — 150 — 1 — 45 — 0 — 4 — 32

Q—Quiet Electric Drive

Application:

G—Gas Boosting C—Liquid CO₂

Type:

D—Single Stage T—Two Stage

Gas Piston(s) Size:

Single Stage: 150, 90, 63

Two Stage: 150/90, 150/63, 90/63

Gas Barrel Construction:

1—15-5 PH (non-H₂ service) 2—A286

Gas Section O-Ring:

Blank—Viton

32—NBR—90 (CO₂ service)

30—Kalrez

13—EPR

Aftercooler:

3—Included

4—None

Electrical Rating:

0—Non-hazardous environment

A—ATEX/Hazardous environment

Drive Power Output in KW

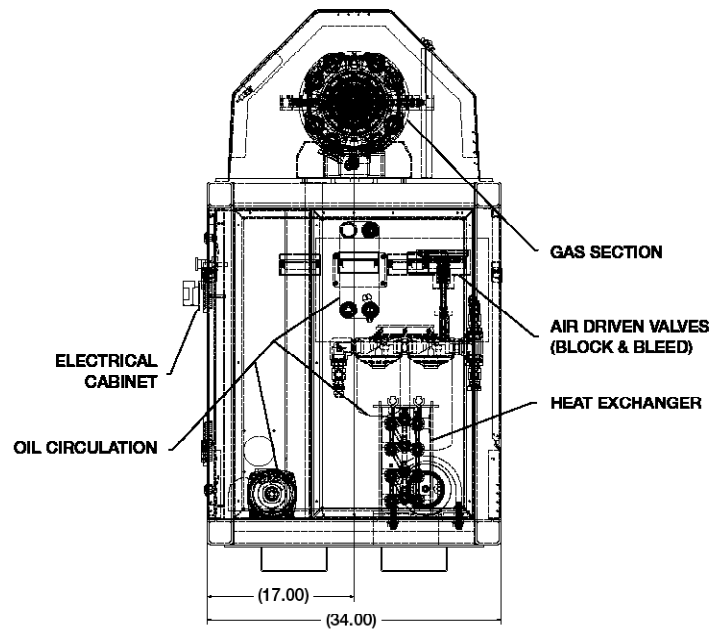
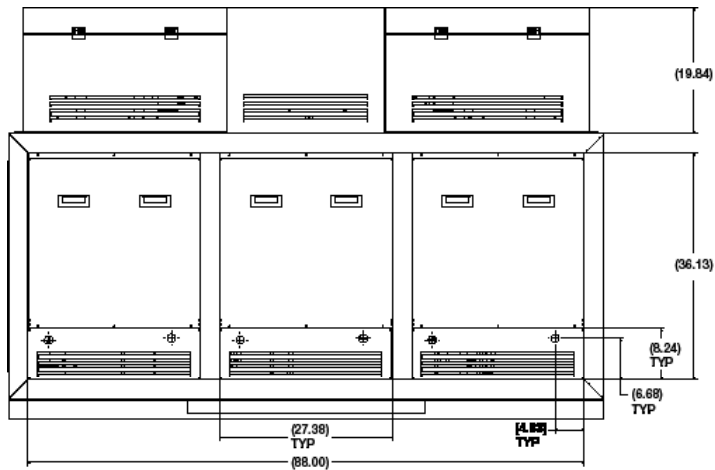
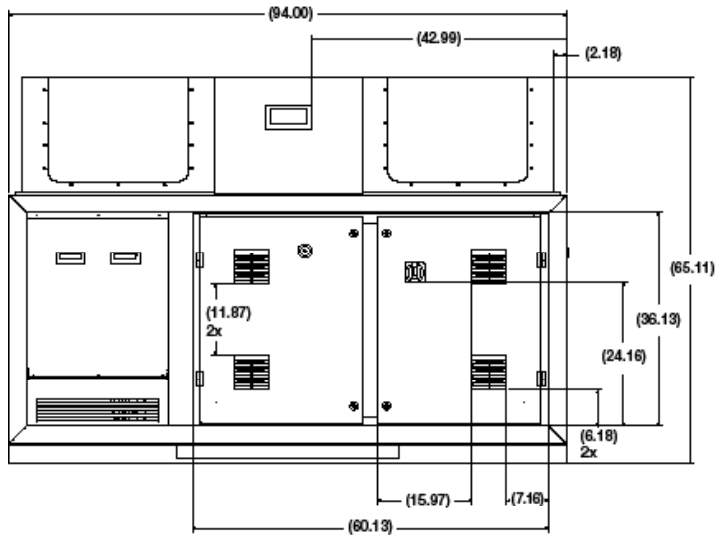

CONTACT HASKEL

haskel.com | sales@haskel.com | saleseurope@haskel.com

Haskel® is a brand of Ingersoll Rand (NYSE:IR). For more information, visit www.ingersollrand.com